

Transformation of Power System Network Operation: TSO-DSO interactions

Dr. Ivana Kockar

*Department of Electronic and Electrical Engineering
University of Strathclyde*

Ivana.kockar@strath.ac.uk

*NTNU webinar on TSO-DSO interaction on flexible resources
12th December 2022*

Overview

- New operational and planning challenges
- Approaches to increase renewable resource connections on distribution networks in the UK
- Implications of DG connections on TSO-DSO interface
- Managing TSO-DSO interactions:
 - SmartNet project in EU
 - ENA Open Networks project in the UK

New operational and planning challenges

- Changes in nature of distribution networks
 - becoming more active
- Stochastic nature of DERs
- Intertemporal constraints imposed by some technologies such as storage, electric vehicles, and demand response
- Changes at transmission and distribution network interfaces
- Provision of ancillary services by DER connected at the distribution network to transmission and/or distribution system operators.

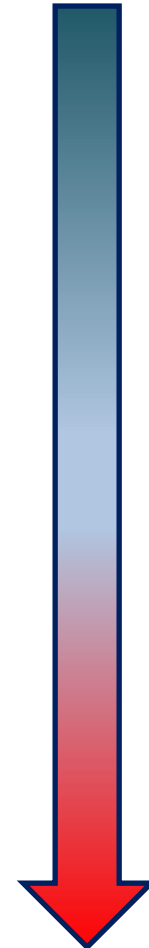

Active Network Management

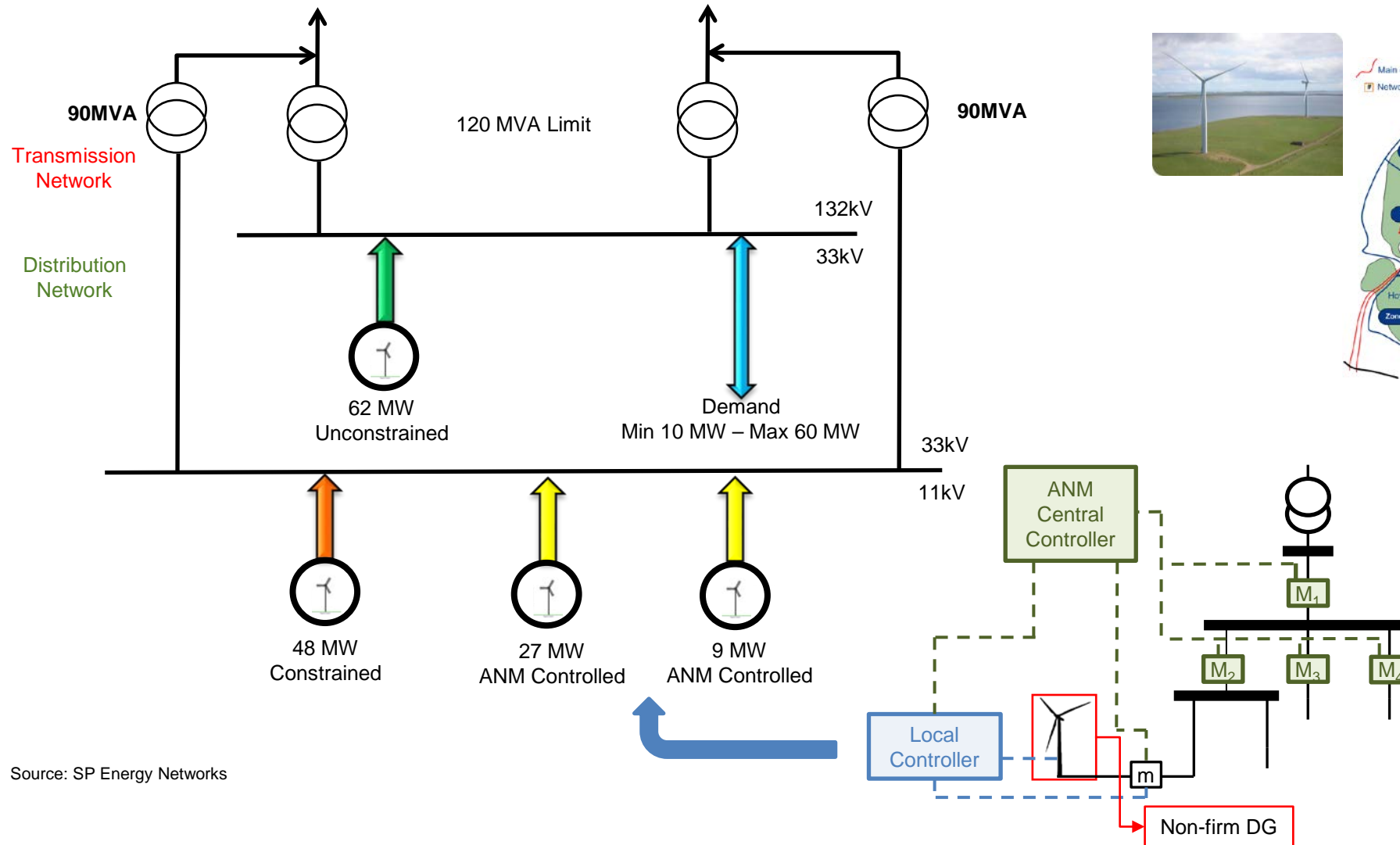

Source: SP Energy Networks

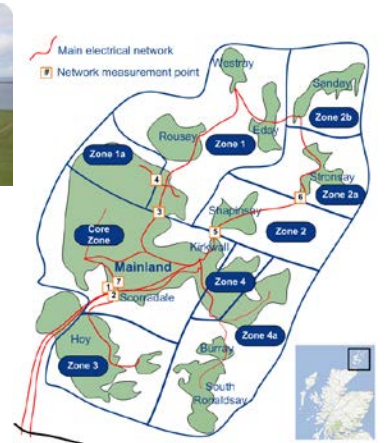

Source: SSE

NINES project – Scottish and Southern Electric

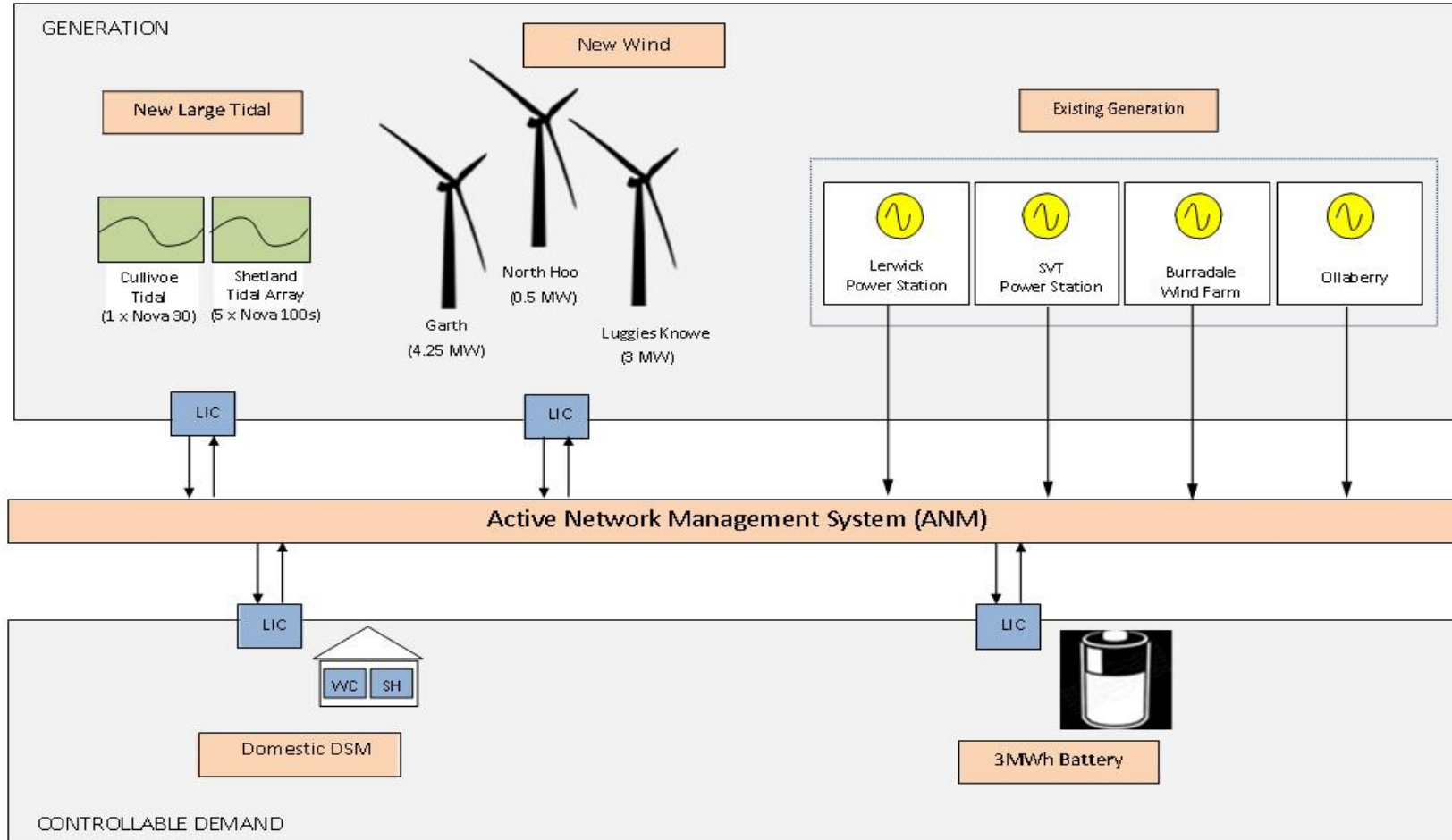

Source: SSE



ARC – Network Capacity

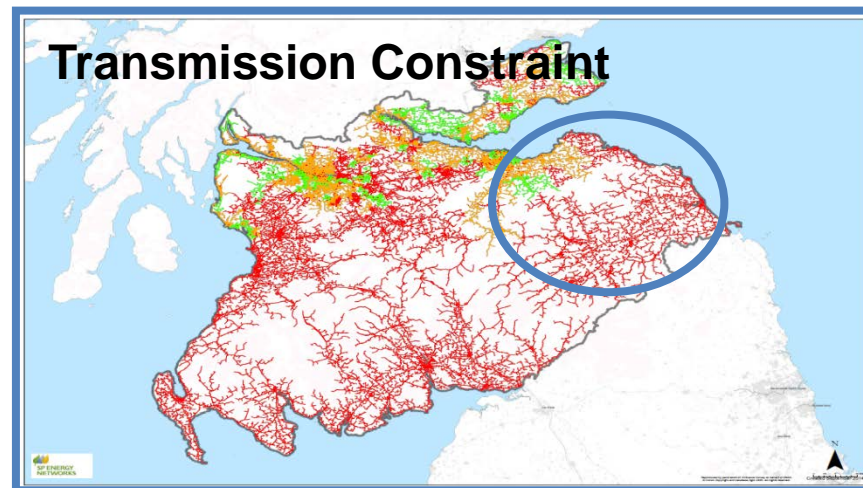
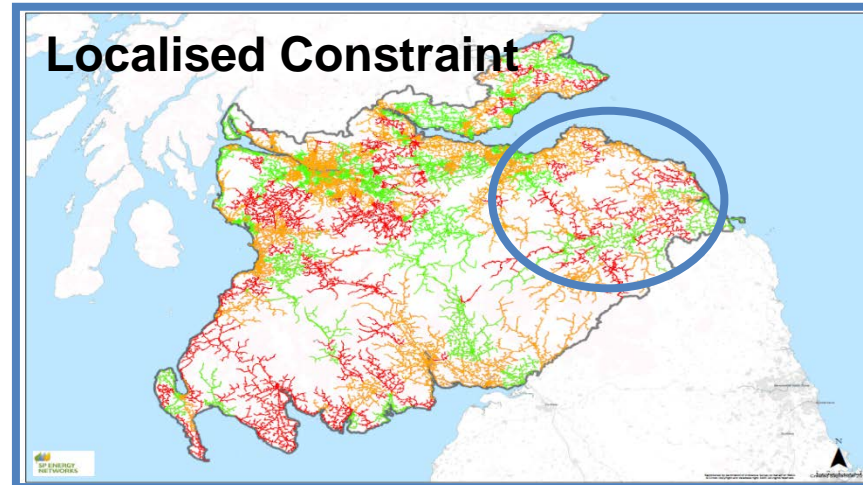

TSO-DSO Interface

➤ Future distribution networks with DER will inject a growing amount of energy into the transmission system

- DERs can provide
 - local services for the distribution grid (voltage regulation, congestion management)
 - services for the entire system through the connection point to the transmission grids

➤ Now

- In the UK: ANM is BaU (Business as Usual)

➤ Future: strict real-time coordination between the different actors that are involved in the provision of ancillary services

➤ Optimizing the interface between TSOs and DSOs is crucial to ensure the achievement of an overall efficiency

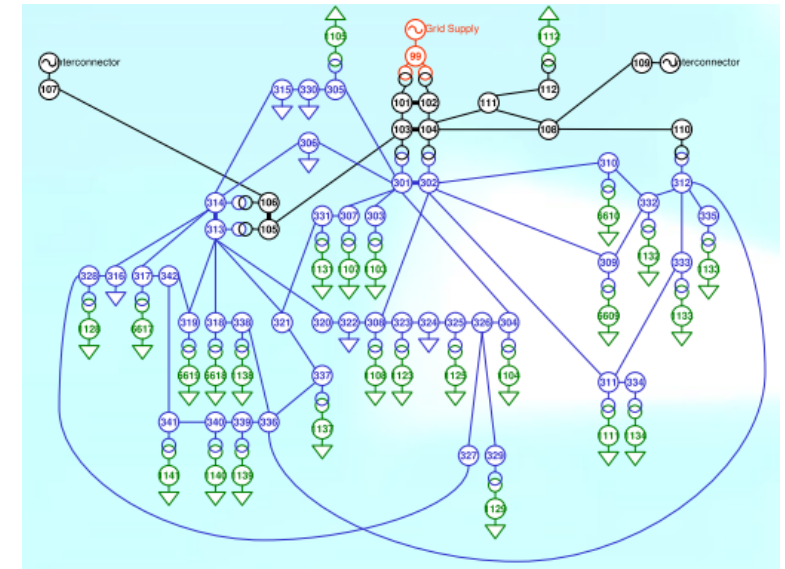

TSO-DSO Interaction

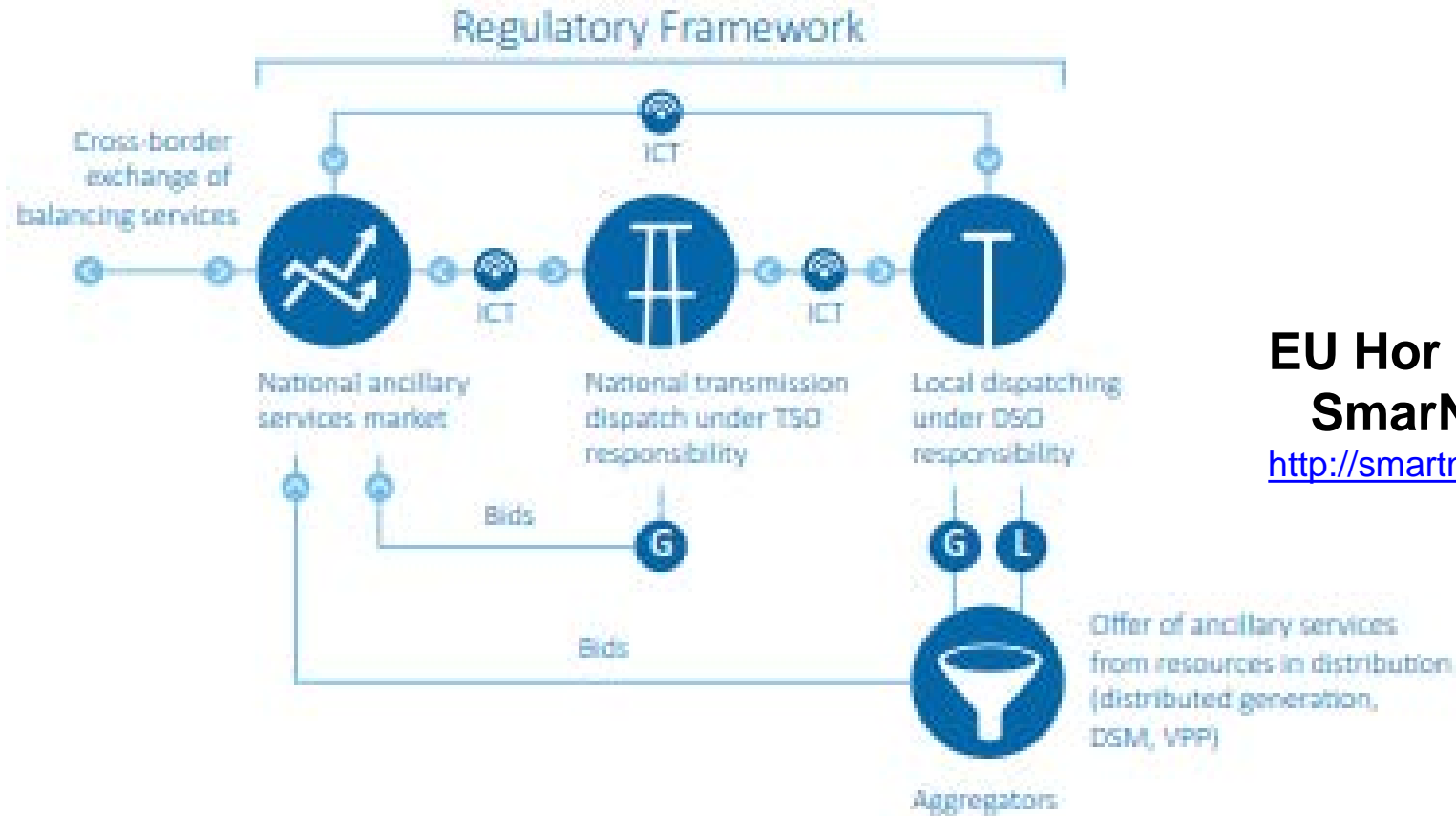

EU Hor 2020
SmarNet project
<http://smartnet-project.eu>

- **In the UK: ENA Open Networks project:**
<http://www.energynetworks.org/electricity/futures/open-networks-project>

TSO-DSO Interaction: key questions

- Increased reserve needs due to significant increase of variable RES
- Opportunities from new DER in distribution networks?
- Some key questions:

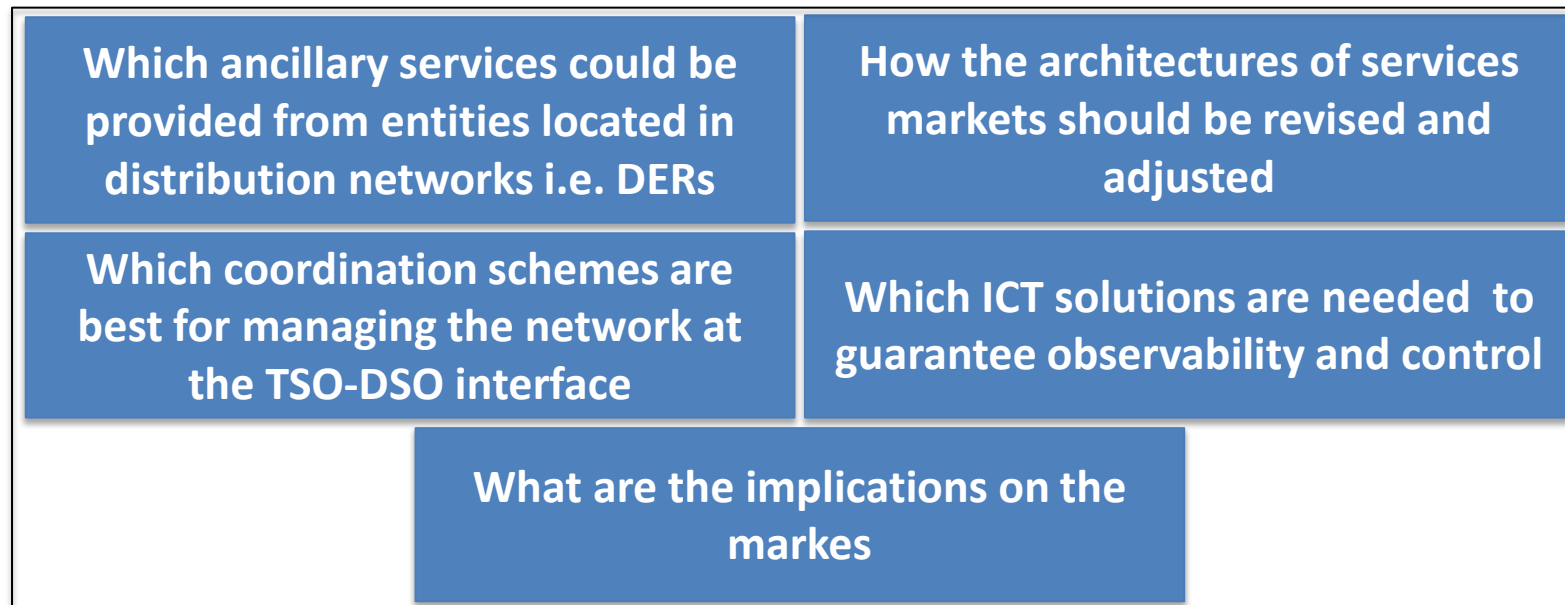

Summary coordination schemes



Coordination scheme	Role of the DSO	Market organization (market operator)	Allocation principle of flexibility from the distribution grid
Centralized AS market model	<ul style="list-style-type: none"> Limited to possible process of prequalification 	Common market (TSO)	Priority for the TSO
Local AS market model	<ul style="list-style-type: none"> Organization of local market Buyer of flexibility for local congestion management Aggregation of resources to central market 	Central market (TSO) Local market (DSO)	Priority for the DSO
Shared Balancing Responsibility model	<ul style="list-style-type: none"> Organization of local market Buyer of flexibility for local congestion management and balancing 	Central market (TSO) Local market (DSO)	Exclusive use for the DSO
Common TSO-DSO AS market model	<ul style="list-style-type: none"> Organization of flexibility market in cooperation with TSO Buyer of flexibility for local congestion management 	Common market (TSO and DSO)	Minimization of total costs of TSO and DSO
		Central market (TSO) Local market (DSO)	
Integrated Flexibility market model	<ul style="list-style-type: none"> Buyer of flexibility for local congestion management 	Common market (independent market operator)	Highest willingness to pay

Transition towards DSOs in the UK

- ENA Open Network project in the UK
 - Looks at various aspects related to network transition and TSO-DSO interactions
 - Development and opening of markets for flexibility to defer or avoid network reinforcement
 - Address network capacity and influence of export from DNO to TSO
 - Enable better system coordination
 - TSO-DSO for provision of flexibility across the systems, i.e. at both transmission and distribution levels
 - This also led towards local provision of flexibility by DERs
 - Reduce costs to customers
 - Flexibility becomes a key

Local provision of flexibility

➤ Local provision of flexibility

- Flexibility Tenders/Markets (platforms and contracts)
 - Piclo Flex & <https://www.flexiblepower.co.uk/>
- Community projects
 - Looking into integration of different technologies and evaluating customer engagement via community
- Peer-to-Peer trading
 - Engagement by prosumers to exchange energy locally
 - Exchange of network capacity between DGs/DERs
- Aggregators and VPPs
 - Can be large, but also at community level

Virtual Power Plant

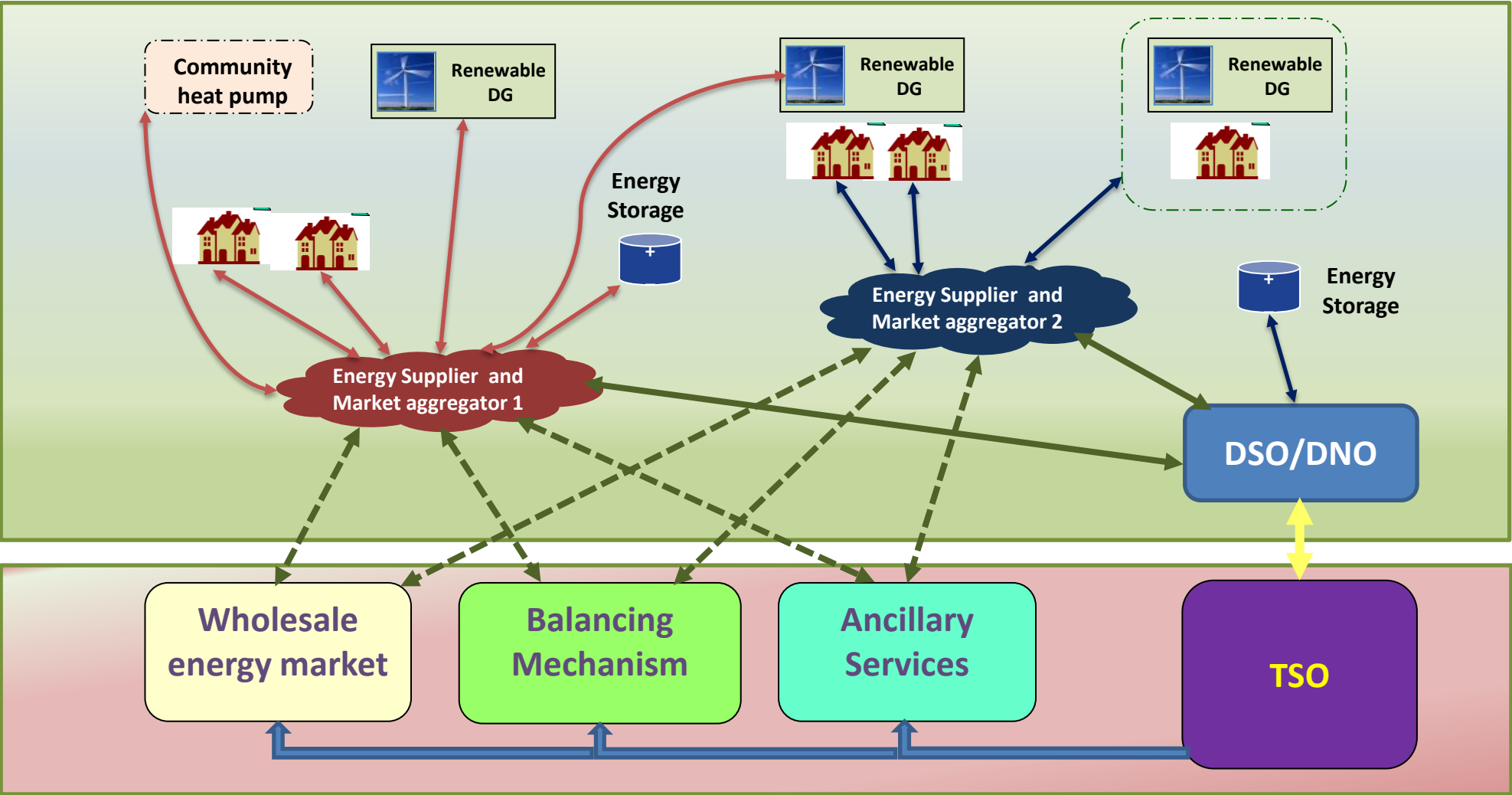

Flexibility services at Distribution level

<https://www.flexiblepower.co.uk/>

- Secure service - scheduled constraint management
 - used to manage peak demand loading on the network and pre-emptively reduce network loading

- Secure Service - pre-fault constraint management
 - manage peak demand loading on the network and pre-emptively reduce network loading

- Dynamic Service - post-fault constraint management
 - support the network in the event of specific fault conditions, often during summer maintenance work

- Restore Service - restoration support management
 - help with restoration following rare fault conditions

Flexibility services at Distribution level

	Sustain	Secure	Dynamic	Restore
Use Case	Scheduled	Pre-fault	Post-fault	Post-fault network restoration
Availability Payment	Yes, for scheduled availability pre-agreed within contract	Yes, payment for availability at week-ahead	Yes, payment for availability at week-ahead	No
Utilisation Payment	Yes	Yes	Yes	Yes
Availability Declarations	Week-ahead. By midnight every Wednesday for the following week (Mon-Sun)	Week-ahead. By midnight every Wednesday for the following week (Mon-Sun)	Week-ahead. By midnight every Wednesday for the following week (Mon-Sun)	Week-ahead. By midnight every Wednesday for the following week (Mon-Sun)
Dispatch Notice	Fixed within contract and notice sent 15 minutes ahead of requirements	Fixed week-ahead on acceptance of availability and notice sent 15 minutes ahead of requirements	Notice sent 15 minutes ahead of requirements	Notice sent 15 minutes of requirements

Flexibility services at Distribution level: maps and auctions

➤ National Grid

- <https://www.nationalgrid.co.uk/network-flexibility-map-application>

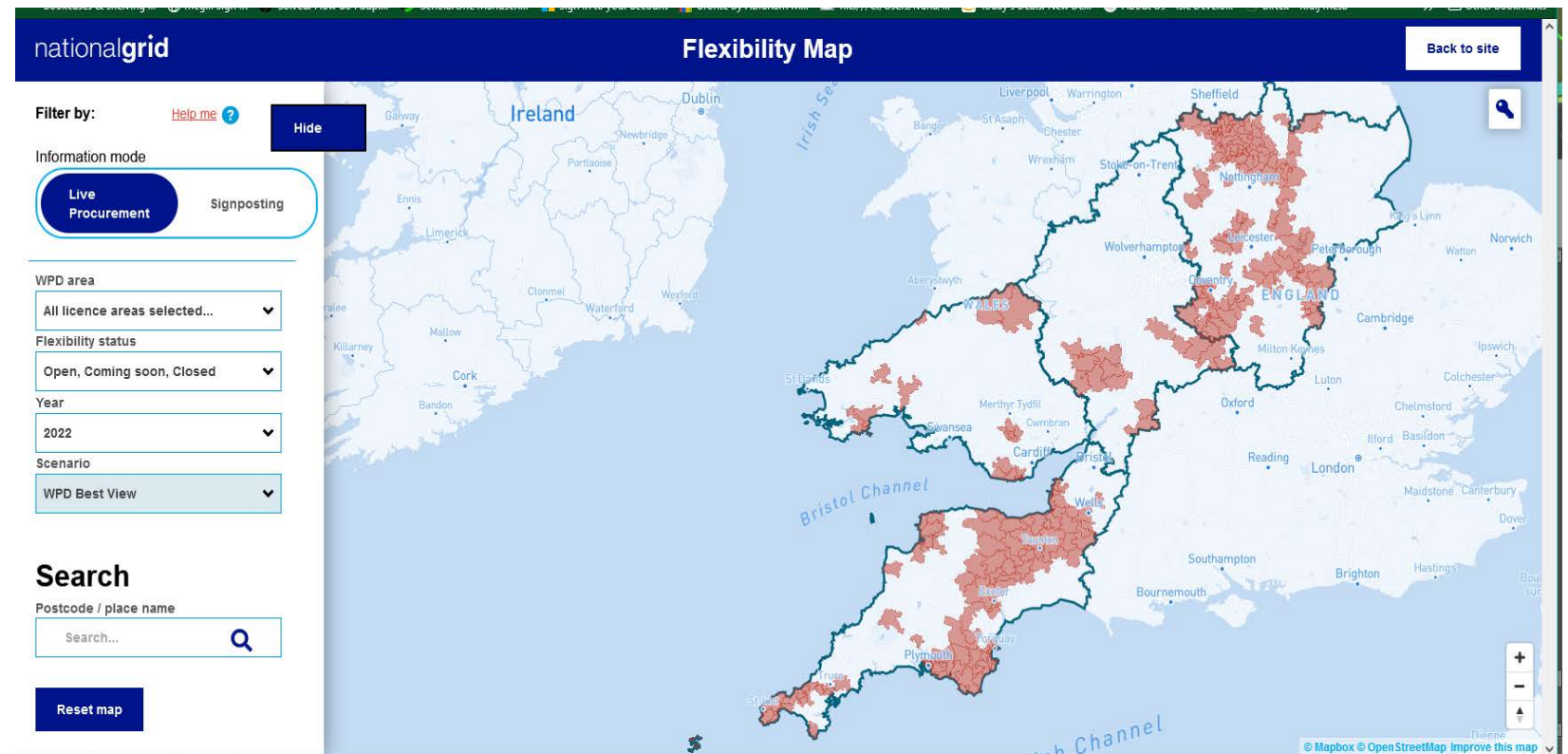

Flexibility services at Distribution level: maps and auctions

➤ Distribution Network Auctions

- <https://picoflex.com/>
- <https://picoflex.com/dashboard>

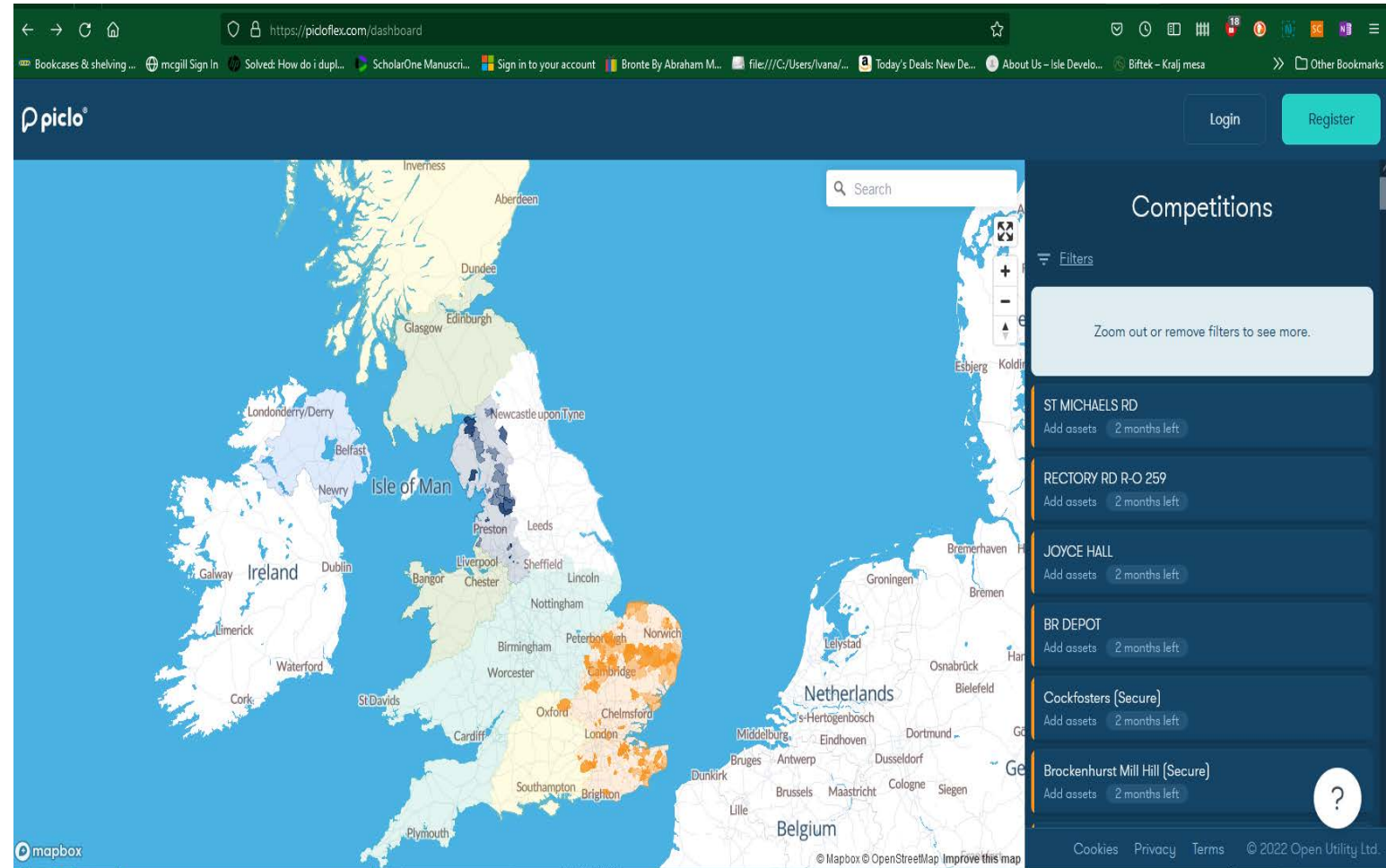

Conclusions

- Implications of DG connections on TSO-DSO interface
- Managing TSO-DSO interactions:
 - A need to coordinate provision of ancillary services and flexibility between TSO and DSO
 - Coordination schemes that depend on particular power systems
 - ENA Open Networks project in the UK
 - Looking at various aspects (flexibility provision, DSO transition, Whole Energy Systems etc.)
 - Auctions for provision of flexibility services at DN level are becoming BaU

Many thanks!

Dr. Ivana Kockar

*Department of Electronic and Electrical Engineering
University of Strathclyde*

Ivana.kockar@strath.ac.uk

