

# Hydrogen Production from Wind and Hydro Power in Constrained Transmission Grids, Considering the stochasticity of wind power

Espen Flo Bødal and Magnus Korpås

# Exploiting energy resources in remote regions

- Many good natural gas and wind resources are located in remote regions
- Lacking transmission capacity and long distances makes development of these resources expensive
- Raggovidda

# Hyper Project

- Large scale production of hydrogen from natural gas with CCS, wind and hydro power
  - Storing CO<sub>2</sub> in depleted natural gas reservoirs
  - Producing hydrogen by electrolysis
- Liquefaction to liquid hydrogen and transportation to energy deficit area
- Creates a supply chain for hydrogen
- Flexible production of hydrogen can increase utilization and reduce need for new of transmission lines



# Wind Power Stochasticity

- How important is it to include wind power stochasticity in the models?
  - How does it affect costs?
  - How does it affect storage strategies?
  - Does the effect of including hydrogen storage change?

# Regional Power System Model

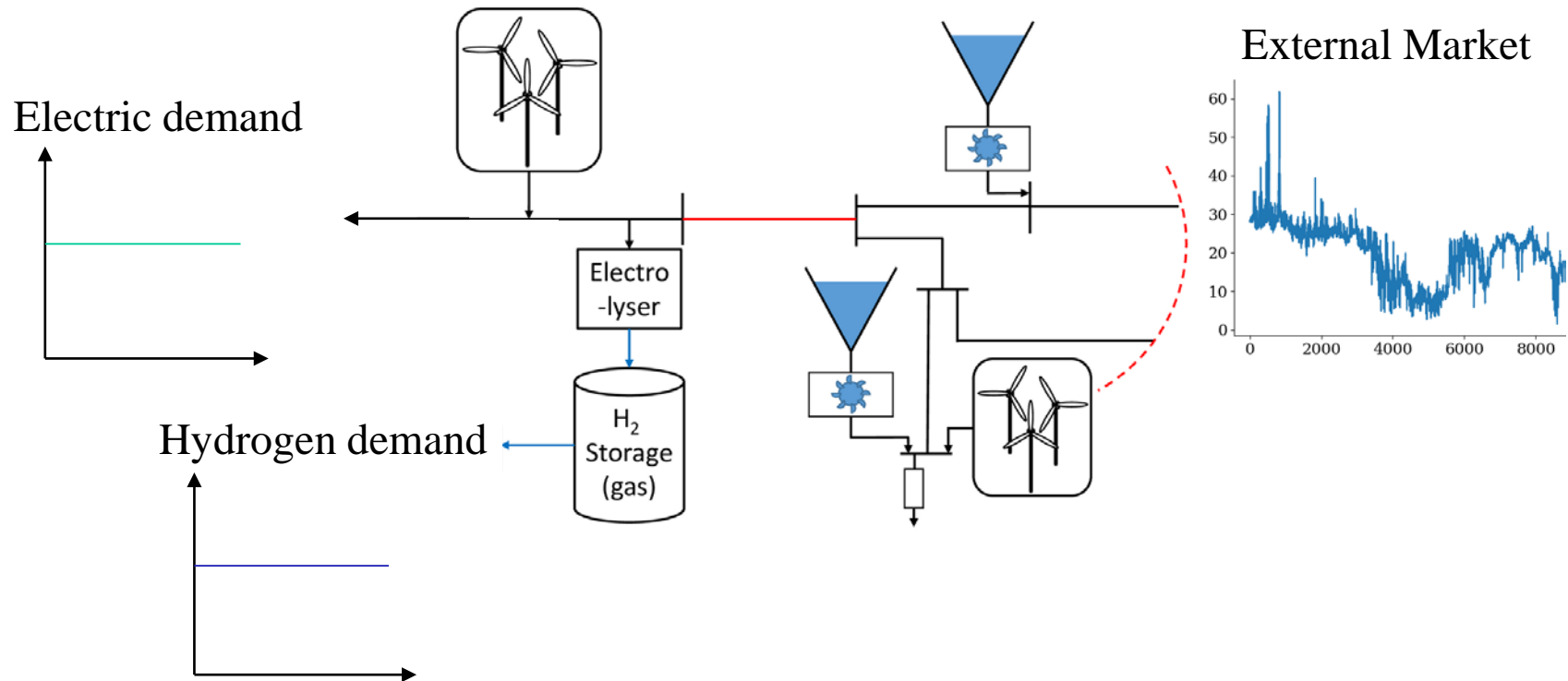

# Wind Forecasting

- Meteorological forecasts and historic production
- Local quantile regression
- Sampling scenarios, including spatial and temporal correlations

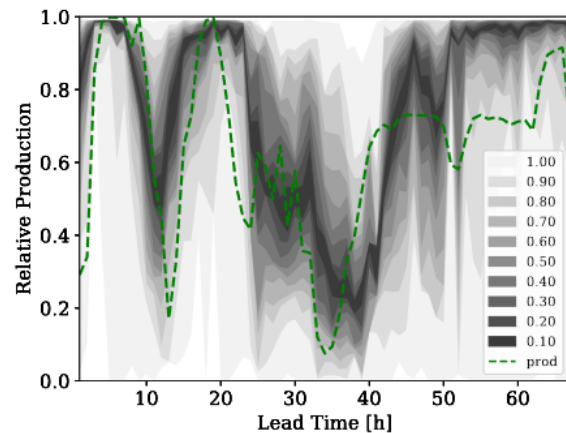

(a) Quantile forecast of relative production for Rag-govidda wind farm in northern Norway.

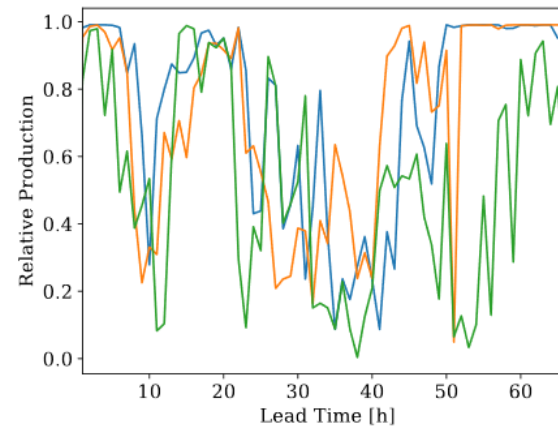

(b) Scenarios of wind power production sampled from the quantile distribution.

Figure 1: Quantile forecasts are used to create wind power scenarios for the stochastic model.

# Rolling Horizon Model

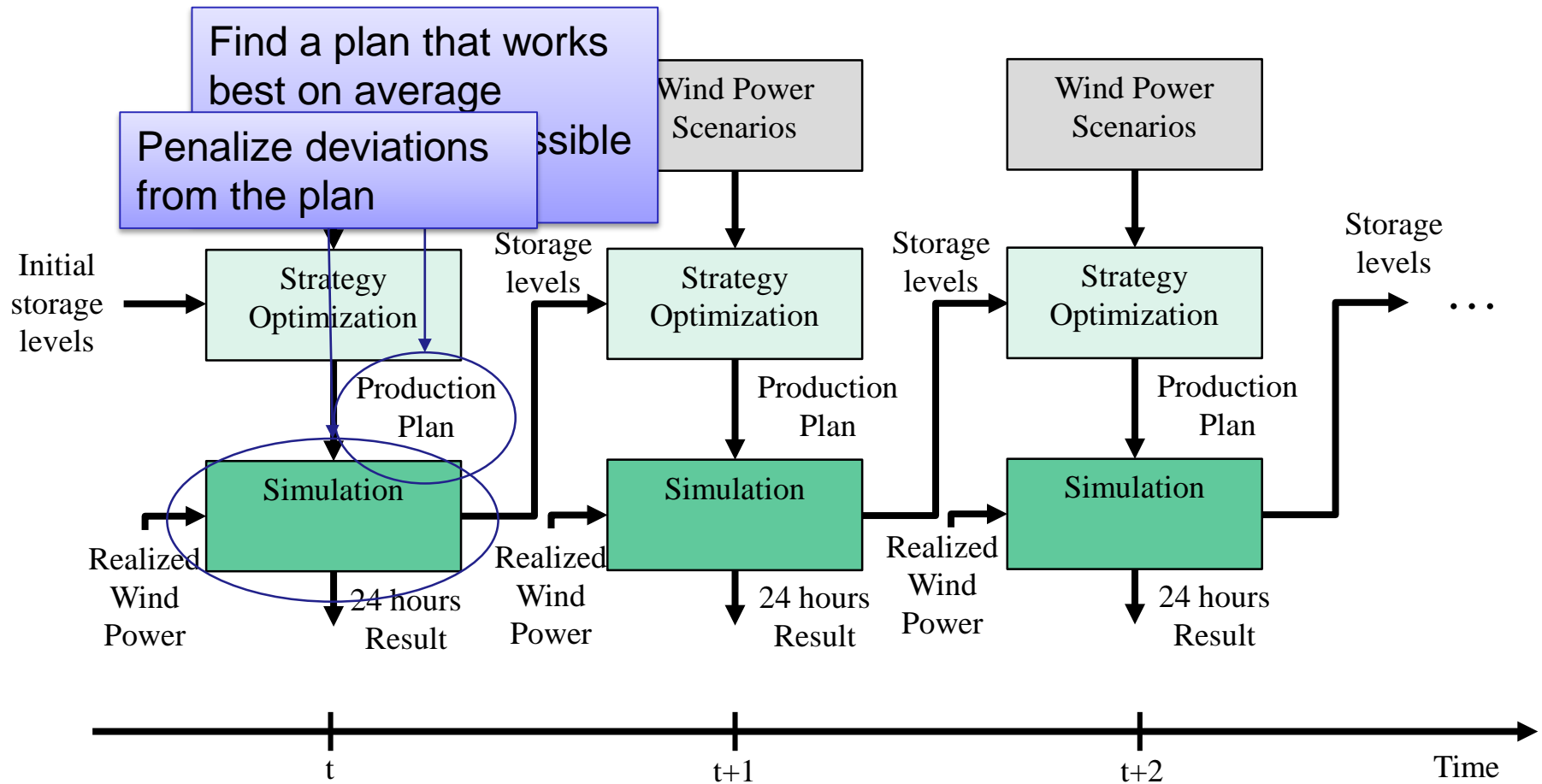

# Case Study

- Finnmark in northern Norway
- Good wind potential and LNG production facility
- Weak transmission connection to the rest of the Nordic power system
- Modelled by a 9 bus system
- Simulated over a period of 10 days

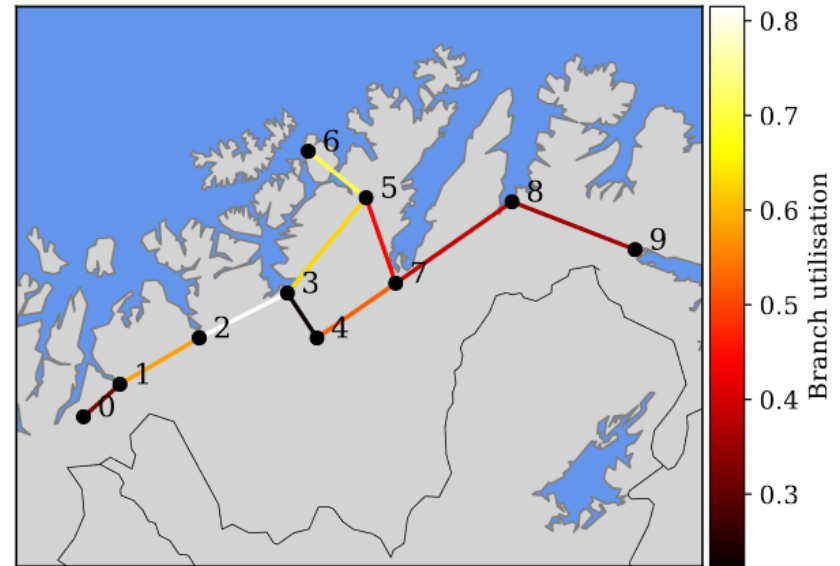
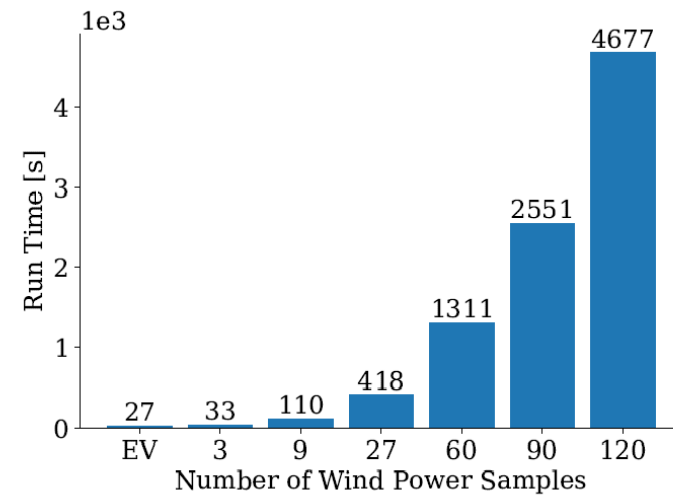
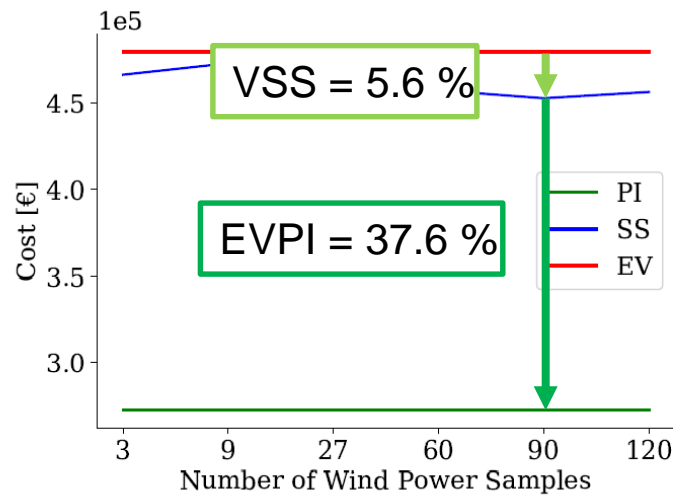

Figure 2: Case study system based on the power system in Finnmark, northern Norway. Lines are colored according to the line utilization in the run with 120 wind power samples. Power is on average flowing from both ends towards node 6.



# Model Performance



(a) Profit information expected **Dependent on penalty cost which is high in this case** affect the

(b) Run time of the strategy calculation, the run time in the simulator is negligible.

Figure 3: value of the solution and run time for the strategy calculation, showing the performance of the model.

# Lost Energy and Cost Breakdown

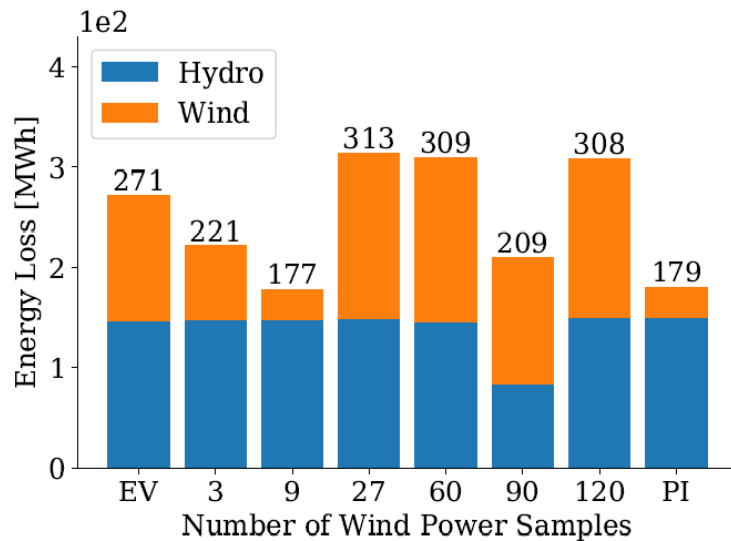

(a) Energy lost from spilling water in hydro power plants or curtailing wind power production.

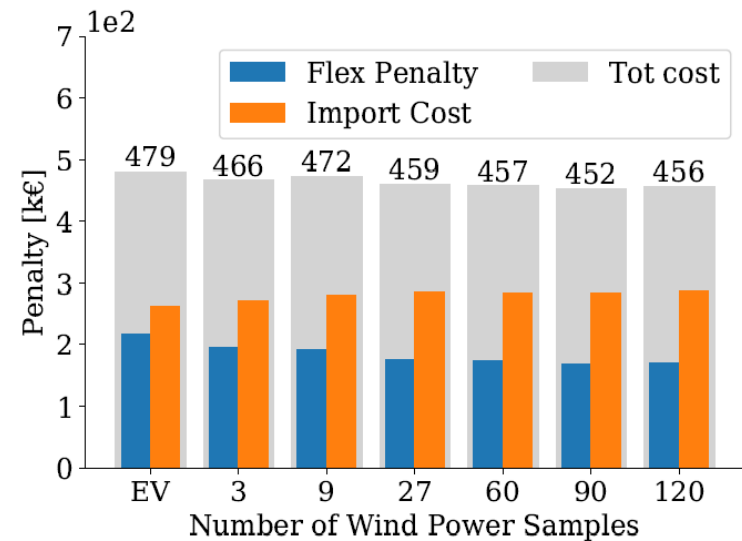

(b) Penalty and import costs obtained in the different runs of the model. Values in excess of perfect information solution.

Figure 4: Energy lost and system costs in excess of the perfect information solution.

# Hydrogen Storage Strategy

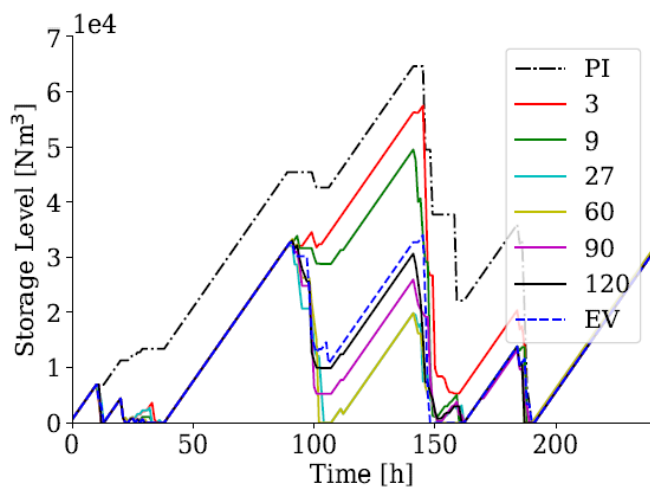

(a) Storage level in hydrogen storage in bus 6.

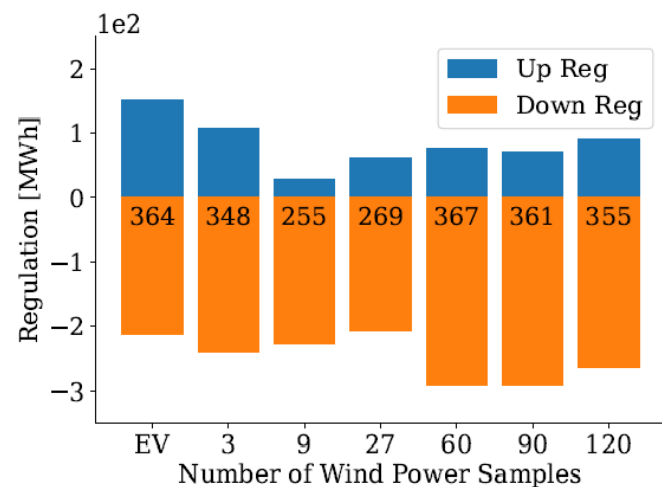

(b) Up and down regulation of the hydrogen load for the different cases. The total up and down regulation is stated inside the bars.

Figure 5: Hydrogen storage level and regulation of the hydrogen plant.

# Power Flow

- Hydrogen storage VS no hydrogen storage
- Slightly higher flow in storage case, increased flow on average by:
  - EV: 0.38 %
  - S120: 0.70 %
  - PI: 1.21 %
- The system already has high flexibility from hydro power
- Hydrogen load could be placed better or distributed to give more effect
- No storage results in rationing of 9.8 MW in all cases

# Conclusion

- A rolling horizon model was developed for assessing the value of including stochastic wind power in a regional power system with hydrogen production
- Case study shows:
  - Reduced costs of 5.6% compared to deterministic solution
  - Potential of reducing costs in stochastic solution up to 37.6%
  - Lower regulation cost and higher import for the better solutions
  - Similar solutions for more than 60 wind samples
  - More flow on the transmission lines when storage is included, better improvement for better uncertainty representation
  - Storage helps to avoid very expensive rationing