

HighEFF innovations

Summary of the 41 innovations
from eight years of research

HighEFF **World's cleanest industry**



÷ 10 %

Greenhouse gas emissions

÷ 30 %

Specific energy consumption



Increased value creation



HighEFF has mapped innovations from eight years of research. On the following pages you can read about all of them, and how they contribute to the HighEFF goals.

HighEFF Overall goals

HighEFF will spearhead the development and commissioning of emerging, energy efficient and cross-sectorial technologies for the industry, and:



Enable 20-30% reduction in specific energy use and 10% in emissions through implementation of the developed technologies and solutions, hence support the EU target of 40% reduction in greenhouse gas emissions and 27% increase in energy efficiency by 2030.



Allow value creation for the Norwegian industry by developing 15-20 new innovative solutions for energy and cost-efficient plants, energy recovery and utilization of surplus heat.



Develop methods and tools for analysis, design and optimization of energy efficient systems.

Content

• MultiEFF – Evaluating the Multiple Benefits of Energy Efficiency Projects	5
• Energy Recovery and CO ₂ Capture for the Aluminium Industry (PGR)	6
• FlexHX – Heat Exchanger modelling framework	7
• Heat Exchanger test rig	8
• Propane-Butane High Temperature Heat Pump	9
• Improved reliability and efficiency for compressor parts	10
• Experimental Development of oil free High temperature heat pump	11
• Energy recovery from metal casting with integrated thermal storage	12
• FlexCS - Cycle Simulation framework	13
• Steam producing heat pumps	14
• Cold thermal energy storage (CTES)	15
• Optimal selection of thermal energy storage technology for fossil-free steam production	16
• Thermal energy storage for improved recovery of industrial waste heat	17
• Energy Cascading	18
• Flue gas recirculation for Silicon Production	19
• Improving prereduction behaviour to decrease energy and carbon consumption	20
• Novel heat recovery concept for aluminium smelter off-gas	21
• Assessment method for thermal energy storage sizing with variable surplus heat streams	22
• Novel perspectives on barriers and enablers	23
• Resource and energy collaborations handbook	24
• DigiHP - Towards digitalization of heat pumps by using ML and IoT for optimal operation	25
• HighEffEC: Reduction of CO ₂ emissions from industrial processes through integration of high-efficiency H ₂ O/CO ₂ electrolysis	26
• INTERCUR – Integrated Energy Systems for Industrial Clusters	27
• Digital twin for additive manufacturing of heat exchangers	28
• Next Generation Casting Process for the Ferroalloy Industry	29
• NEIC Biochar 1 & 2	30
• ITChES – Integration of ThermoChemical Energy Storage	31
• PrintUP – 3D-printed ejector parts	32
• SOCTES Innovative State-of-charge and Output Control of PCM-TES systems	33
• TES-AC Demo-prosjekt REMA 1000 Orkidéhøgda	34
• Pre-heating of anodes in primary production of aluminium	35
• Electricity generation from CO-rich off-gas from ferroalloy production	36
• Drying, preheating or prereduction of Mn ores using CO-rich off-gas	37
• H ₂ production from CO-rich off-gas	38
• Oil & Gas heat pump concept	39
• Flexible offshore oil and gas platform model	40
• Combined heating and cooling with TES in food industry	41
• HTHP integration in the fish industry	42
• Integrated HTHP and TES for combined heating and cooling in dairy sector	43
• Agricluster for low temperature surplus heat utilization	44
• Cost evaluation of industrial heat recovery for external usage	45



MultiEFF – Evaluating the Multiple Benefits of Energy Efficiency Projects

Innovation Type:
Software



Development stage:
Second version available

Contact: Truls Flatberg
(Truls.Flatberg@sintef.no)

Challenge

As companies strive to enhance energy efficiency, they encounter a common hurdle: evaluating diverse energy-saving initiatives and projects. The challenge lies in selecting the most impactful projects while considering economic viability and environmental benefits. Balancing these factors requires a systematic approach that aligns with organizational goals.

Solution

MultiEFF is a macro-based Excel workbook that can be used to **assess** the **multiple facets** following investments into energy-saving technologies or measures. Designed for project start-up, it guides decision-makers in making informed choices. The primary focus is on **cost, emission reductions** and potential **energy savings**, but it also includes less tangible impacts, such as effects on the **work environment, company reputation, potential risks** and **health, safety, and environment (HSE)**. The tool has been developed in cooperation with Hydro, discussing use cases and functional requirements, but is designed to be a general tool applicable to other companies and industries.

Potential

A systematic evaluation of energy efficiency measures using MultiEFF can serve as a catalyst for adopting new technologies and demonstrating the benefits of investing in energy improvement projects. By consistently applying this approach to compare projects and alternatives within a company, organizations can effectively prioritize activities with the greatest potential impact from both economic and environmental standpoints.

Executive summary	
CO2 emissions reduction	240.60 tonne/yr
Annual energy savings	1089000.00 kWh
Annual primary energy savings	3079200.00 kWh/yr
Total operating costs savings	36000.00 KNOK
Annualized operating costs savings	1800.00 KNOK/yr
Return on investment	28.35 %
Internal rate of return	39.49 %

Additional benefits score chart

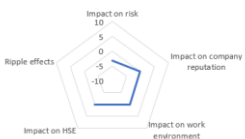

HighEFF goals contribution:



÷ 10 %

Greenhouse gas emissions



÷ 30 %

Specific energy consumption



Increased value creation

Contribution towards HighEFF goals:

The MultiEFF tool is considered an enabling innovation. It may be applied as a tool to evaluate new ideas and technology improvements that give impacts within all HighEFF goal categories and industry sectors.





Energy Recovery and CO₂ Capture for the Aluminium Industry (PGR)

Innovation Type:
Process Concept



Development stage (TRL):
Theoretical Analysis. Need to be tested.

Contact: Samuel Senanu
(samuel.senanu@sintef.no)

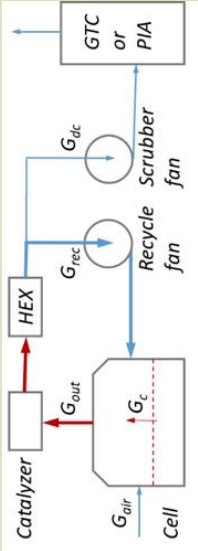

Presently, close to 40 % of the waste energy generated from aluminium production by the aluminium industry is lost in the off-gas. Also, the CO₂ concentration in the off-gas is very low, thus, making it difficult for economical carbon capture and storage (CCS) by the industry.

Challenge

50 % of the ca. 13.5 MWh required to produce a tonne of aluminium is lost as waste heat during production. Close to 40 % of this waste heat ends up in the off-gases leaving the electrolysis cell. Additionally, the CO₂ concentration in the off-gas is very low for economical carbon capture and storage (CCS).

Solution

A concept involving recycling of the off-gases to increase the CO₂ concentration and recover the waste energy by using a heat exchanger (HEX) provides a possible solution.

Potential

- ca. 2 MWh/t Al energy recovery meaning ca. 2 TWh annual energy recovery for the Norwegian Aluminium industry with ca. 1 million tonnes of annual Al production.
- Increased CO₂ concentration in the off-gas to ca. 3-4 vol%
- A CO₂-free aluminium production by 2030 using a suitable CCS technology.

Reference

- [1] Solheim A, Senanu S (2020): Recycling of the Flue Gas from Aluminium Electrolysis Cells Light Metals 2020, 803-810.
- [2] Senanu S, Solheim S (2021): Gas Recycling and Energy Recovery. Future Handling of Flue Gas from Aluminium Electrolysis Cells Light Metals 2022.

HighEFF goals contribution:



÷ 10 %

Greenhouse gas emissions



÷ 30 %

Specific energy consumption



Increased value creation

Contribution towards HighEFF goals:

The PGR concept will help the aluminium industry to utilise some of the heat losses associated with the process while enabling the industry to get ready for future CCS due to the potential increase in CO₂ concentration in the off-gases.





FlexHX – Heat Exchanger modelling framework

Innovation Type:

Model



Development stage (TRL):

TRL: 4-7

Contact: Geir Skaugen

Geir.Skaugen@sintef.no

Challenge

Recovering heat from flue gases for the purpose of generating power in a bottoming cycle will require heat exchangers of considerable size and weight. In addition, in cases where flue gases contain particles, additional process constraints like minimum or maximum gas velocities will affect the final design. A detailed physical description for the fluid behaviour through a heat exchanger where both the geometry and the fluid conditions can change.

Solution

With a flexible, object-oriented modelling framework, special local heat exchanger design features can be included in the description. The modelling framework consists of basic building blocks for describing exchange of heat between fluid(s) and surface(s) so that these elements can be combined to describe a relevant heat exchanger of existing or novel design. The focus of the innovation is to have a robust, accurate and fast solution method so that in combination with innovation 13.1.3 a design optimisation can be performed given geometrical or process constraints.

Potential

Can be used to model new heat exchanger concepts and contribute to reduce size, weight and cost of, for instance, heat recovery heat exchangers and thus increase the implementation and the use of bottoming cycles.

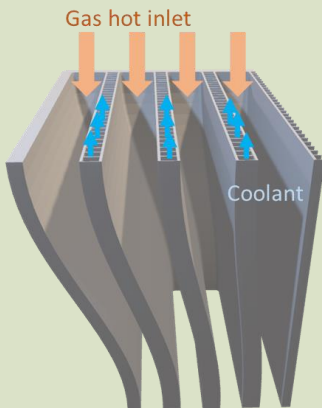

HighEFF goals contribution:



÷ 10 %

Greenhouse gas emissions



÷ 30 %

Specific energy consumption



Increased value creation

Contribution towards HighEFF goals:

The FlexHX heat exchanger modeling framework is considered an enabling innovation. It may be applied as a tool to develop and validate existing or novel heat exchanger concepts, impacting within all HighEFF goal categories and industry sectors.





Heat Exchanger test rig

Innovation Type:
Experimental rig



Development stage (TRL):
TRL 4, rig for laboratory verification

Contact:
Magnus Kyrkjebø Vinnes
(Magnus.Vinnes@sintef.no)

Challenge

Hydrocarbons as working fluids in heating and cooling systems have the potential to operate both efficiently and environmentally friendly in different energy systems and can replace traditional working fluids that have a negative impact on the ozone layer and the climate. To utilise this potential heat exchangers must be optimised for the natural working fluids. New heat exchanger concepts and working fluid mixtures are usually developed using computer modelling and simulations and promising concepts that emerge must be experimentally validated. Few existing test rigs can test heat exchangers using hydrocarbon working fluids.

Solution

A new heat exchanger test rig has been built in the HighEFF lab project and was finalised in 2021. The rig design and engineering was supported by simulations and input from RA2. It can test heating and cooling through condensation and evaporation of pure hydrocarbons and hydrocarbon mixtures. The operating conditions of the working fluid in the rig include temperatures from 0 – 150°C, pressures up to 70 bar, and mass flow rates of up to 17 kg/min, making it suitable for heat exchangers with duties in the range of 20 – 40 kW. The facility is well equipped to measure heat transfer and pressure drop accurately. The test heat exchanger is interchangeable, and any heat exchanger design could be mounted for testing in the rig.

Potential

The results from the test rig can be used to validate simulation results and to test the applicability of different heat transfer correlations for natural working fluids. Furthermore, the performance of new heat exchanger designs can be evaluated in the rig.

Reference

1. Trædal et al., (2020), *Experimental heat exchanger test facility for evaporation and condensation of hydrocarbons*, in: 14th Gustav Lorentzen Conference. doi: [10.18462/iir.gl.2020.1130](https://doi.org/10.18462/iir.gl.2020.1130)
2. <https://www.sintef.no/projectweb/highefflab/>

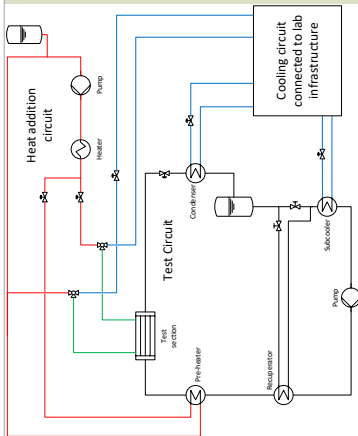

HighEFF goals contribution:



÷ 10 %

Greenhouse gas emissions



÷ 30 %

Specific energy consumption



Increased value creation

Contribution towards HighEFF goals:

Novel heat exchanger designs and improved heat transfer correlations contribute to more efficient heat transfer, in turn increasing the potential for, for example, heat recovery. The results from the heat exchanger test rig thus contribute to reducing the specific energy consumption of various sectors.

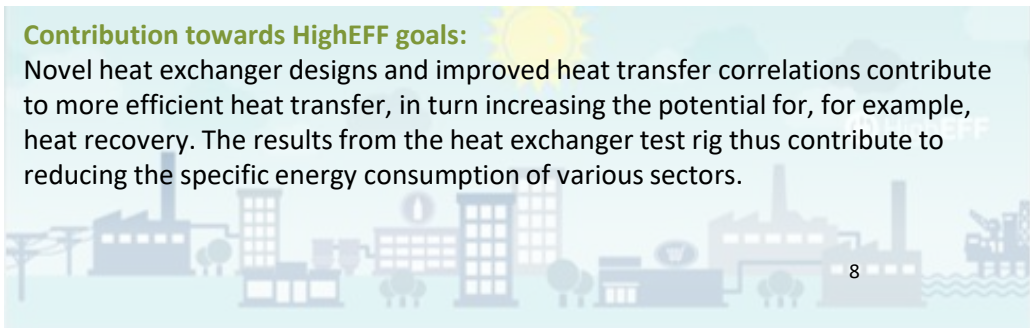



Propane-Butane High Temperature Heat Pump

Innovation Type:
Component
Process



Development stage (TRL):

TRL 7: A laboratory and an industrial scale prototype have been developed and tested successfully.

Contact: Marco Bless

(Marco.Bless@sintef.no)

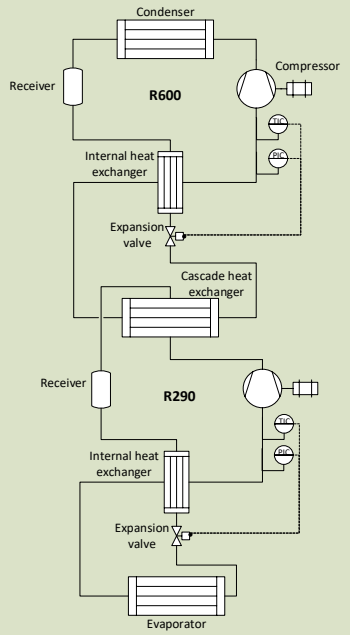

Currently, 25% of the final energy demand in the European industry is used for process heating in a temperature range that allows the use of heat pumps for an energy efficient supply [1]. To reduce heat waste from cooling application and simultaneously increase energy efficiency, heating and cooling applications can be coupled by propane-butane high temperature heat pumps.

Challenge

To meet thermal energy demands, chillers are used for cooling application, which simultaneously produce low quality heat which often is wasted. For heating applications, usually electric boilers or gas-fired boilers are used, thus resulting in high electricity demands or CO₂-emissions. On a component level, reaching high temperatures within the compressor is challenging, due to oil degradation, cooling of the electrical motor and efficiency losses.

Solution

To utilize the low-quality heat from cooling application and simultaneously match heating demands, a propane-butane high temperature heat pump for combined heating and cooling was developed and tested successfully at laboratory (20 kW_{th}) and industrial (300 kW_{th}) scale. Special high temperature compressors from Dorin could thereby prove their capabilities.

Potential

Having an operation limit from -17°C for cooling application to up to 120°C for heating applications, with combined COPs up to around 3.5, thermal energy demands can efficiently be electrified and decarbonised. This can lead to electricity savings of up to 71% for the thermal processes in the application range and corresponds to reduces greenhouse gas emissions close to zero when renewable electricity is used.

Reference

[1] R. de Boer, A. Marina, B. Zühlsdorf, C. Arpagaus, M. Bantle, V. Wik, B. Elmegaard, J. M. Corberan, J. Benson (2020). "Strengthening Industrial Heat Pump Innovation: Decarbonizing Industrial Heat".

HighEFF goals contribution:



÷ 10 %

Greenhouse gas emissions



÷ 30 %

Specific energy consumption



Increased value creation

Contribution towards HighEFF goals:

With enabling combined heating and cooling, the developed propane-butane high temperature heat pump efficiently supplies thermal energy demands. It reduces the specific electricity consumption if an electric boiler is substituted and decarbonises industrial heating application by substituting gas boilers.



Improved reliability and efficiency for compressor parts

Innovation Type:
Model / software



Development stage (TRL):
Being used for parameter studies of real compressors. Up to TRL 7 in direct projects that are spinoffs from HighEFF

Contact: Åsmund Ervik
(asmund.ervik@sintef.no)



Challenge

R&D for improved compressors faces the challenge that optimizing for higher reliability often gives lower efficiency, and vice versa. This is because of complex transient phenomena in the fluid- and solid-mechanic behaviour in these machines.

Solution

SINTEF Energy Research and SINTEF Industry has developed a coupled 3D CFD + FEM model for compressor valves. This coupled model goes beyond state-of-the-art and can take the fully detailed compressor geometry into account.

Potential

The solution can be used to study details of compressor valve operation, showing how flow and mechanical stresses are affected when mechanical design is optimised, in a digital twin solution.

Reference

10th IIR Compressors Conf. (2021),
15th IIR Gustav Lorentzen Conf. (2022),
16th IIR Gustav Lorentzen Conf. (2024).

HighEFF goals contribution:



÷ 10 %

Greenhouse gas emissions



÷ 30 %

Specific energy consumption



Increased value creation

Contribution towards HighEFF goals:

- Better compressors working with natural refrigerants, that have both higher reliability and efficiency, can out-compete solutions where refrigerants have high GWP.
- Improving the efficiency and lifetime of compressors will directly lead to lower energy consumption in refrigeration and heat pumps.
- Increasing maintenance intervals and reducing number of failures in compressors yields value creation both for compressor vendors & users.

Experimental Development of oil free High temperature heat pump

Innovation Type:
Model



Development stage (TRL):
Experimental test rig installed

Contact: Khalid Hamid
Khalid.hamid@ntnu.no

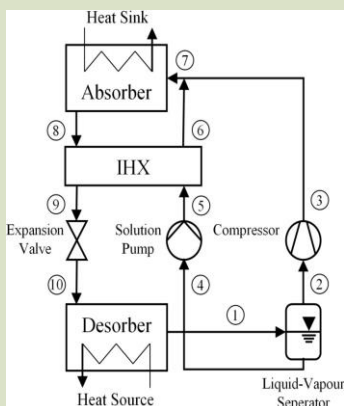

Challenge

Developing oil-free high temperature heat pumps that can reliably operate at high temperatures while maintaining efficiency poses a significant technological challenge. In the pursuit of a more sustainable future, innovations in energy efficiency and environmental responsibility are paramount. Among the myriad technologies contributing to this cause, oil-free high temperature heat pumps stand out as a crucial advancement to provide clean heat for industrial applications.

Experimental development to the existing Solution

The HighEFF project aims to build and establish new knowledge and competencies in the design and application of ACHP systems with ammonia-water mixture as working fluid. The motivation is to support the decarbonization of industrial high temperature processes with enlarged application range by providing higher supply temperatures and improved system. To address the challenges a prototype test rig is installed on-site in the NTNU laboratory. The experimental investigation still continue to further evaluate for different industrial application.

Potential

Many industries requiring both cooling and heating have separate systems for these tasks. Having a combined system capable of providing both demands while utilizing available waste heat can significantly increase the overall energy efficiency. By integrating heat pumps, most of the energy can be recovered from available waste heat.

Reference

Hamid, K., Sajjad, U., Ahrens, M. U., Ren, S., Ganesan, P., Tolstorebrov, I., ... & Eikevik, T. M. (2023). Potential evaluation of integrated high temperature heat pumps: A review of recent advances. Applied Thermal Engineering, 120720.

HighEFF goals contribution:



÷ 10 %

Greenhouse gas emissions



÷ 30 %

Specific energy consumption



Increased value creation

Contribution towards HighEFF goals:

The HighEFFLab project supports this effort by developing and testing different systems and components through the establishment of new experimental test facilities. The utilization and improvement of HTHP technology and its integration into industrial processes is one of the main objectives of the Centre for an Energy Efficient and Competitive Industry for the Future



Energy recovery from metal casting with integrated thermal storage

Innovation Type:
Process concept



Development stage (TRL):
TRL: 3-4

Contact: Trond Andresen
trond.andresen@sintef.no

Challenge

The casting processes in all Norwegian ferroalloy plants are performed batch-wise, while all common forms of heat utilization needs a continuous supply. Furthermore, the initial temperatures of the liquid metal during casting are very high, and heat transfer will dominantly occur via radiation. A heat recovery solution will therefore somehow have to surround the metal during solidification. Combined with demand for efficient production and plant logistics, this adds significant complexity to both heat capture and practical power production.

Solution

A new system concept has been proposed and is currently under evaluation and further refinement. The system utilises an actively cooled tunnel to efficiently absorb heat radiation from casting moulds, as well as thermal energy storage to buffer the intermittent heat for consistent and smooth export to heat-to-power conversion, either in a standalone system or integrated into an existing cycle.

Potential

A 2021 HighEFF case study showed heat recovery potential for a single plant of up to 46 GWh/y captured above ~300 °C. With similar applicability across the whole Norwegian ferroalloy sector, this would equate to over 400 GWh/y of high temperature heat or alternatively 120 GWh/y electric power via heat-to-power conversion.

Reference

Andresen et al., 2020. Dynamic Analysis of Energy Recovery Utilizing Thermal Storage from Batch-wise Metal Casting. IIR Rankine Conference 2020

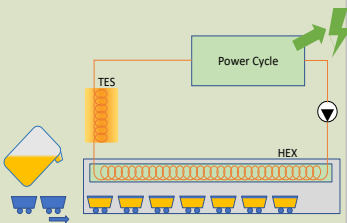

HighEFF goals contribution:



÷ 10 %

Greenhouse gas emissions



÷ 30 %

Specific energy consumption



Increased value creation

Contribution towards HighEFF goals:

The significant quantities and high temperature of the heat rejected during ferroalloy casting makes it an interesting source for energy recovery. The heat released during casting is rarely utilized today.



The energy efficiency potential was calculated for the Norwegian Ferroalloy industry to be production of 400 GWh/y of high temperature heat OR 120 GWh/y electric power.



FlexCS - Cycle Simulation framework

Innovation Type:

Model



Development stage (TRL):

TRL: 4-7

Contact: Geir Skaugen

(Geir.Skaugen@sintef.no)

Challenge

Developing new and improved heating, cooling, and power cycles has broad applicability and impact in a vast number of industrial processes. System models can be powerful tools in such development, but very specific approaches must be taken to predict behavior and performance of technologies that does not yet exist.

Solution

A general modeling framework called FlexCS has been developed by SINTEF over more than a decade, with specific contributions and new additions made from research in HighEFF. It is broadly applied to analyze and optimize solutions for many different technologies and scenarios, for example heat pumping and heat-to-power cycles. A major strength is that the framework is quite generic, and not rooted in the performance of specific technologies.

The FlexCS framework is quite unique and offers capabilities unmatched by commercial products.

Potential

Better understanding of power cycles, both existing and conceptual ones. This paves the way for analysing key limitations to applications and allows optimal design and utilization of power cycles.

Reference

Han Deng, et.al. *Comparing Three Methods for Design Analyses of Rankine Cycle for Waste Heat Recovery from Natural Gas Compression*. IIR International Rankine 2020 Conference -Heating, Cooling and Power Generation – 26-29 July 2020, Glasgow, UK

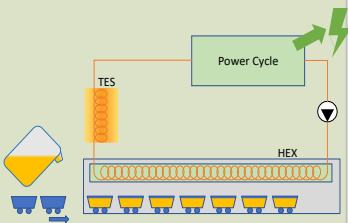

Simple concept sketch

HighEFF goals contribution:



÷ 10 %

Greenhouse gas emissions



÷ 30 %

Specific energy consumption



Increased value creation

Contribution towards HighEFF goals:

The FlexCS system modeling framework is considered an enabling innovation. It may be applied as a tool to develop and validate new ideas and technology improvements that give impacts within all HighEFF goal categories and industry sectors.





Steam producing heat pumps

Innovation Type:
Technology



Development stage (TRL):

TRL: 5-6

Contact: Ole Marius Moen
(ole.moen@sintef.no)

HTHP cycle concept for upgrading surplus heat to 10 bar steam, displacing fossil fuel based on compact turbo compressors using water as working fluid

Challenge

Heating demands in the Norwegian industry are still to a large degree covered via fossil fuel sources or using inefficient direct electric heating. Many of these industries generate a significant amount of waste heat which could be upgraded and re-used back into the process using High-Temperature Heat Pumps (HTHPs). HTHP technology can therefore reduce industrial emissions, improve energy efficiency through utilization of waste heat, and help reduce the load on the electrical grid. Heat pumps traditionally use synthetic working fluids. However, due to issues with these substances, such as high GWP-values and potential environmental hazards with PFAs, there is a need to develop HTHP technology that is based on natural working fluids which are future-proof.

Solution

A HTHP concept based on water/steam (R718) as working fluid, using compact high-speed turbo-compressors have been developed, built and tested in SINTEFs laboratories, together with HighEFF partner Epcon. Two compressors are installed in series to increase the achievable pressure ratio. R718 is an excellent natural working fluid in many ways: It is cheap and readily available, non-toxic and non-flammable, and a high critical temperature means it is suitable for industrial processes which require steam supply at 10-20 bar. Experimental work to map the performance of the latest versions of the compressors is now underway.

Potential

The automotive derived turbo compressors allows for a very compact heat pump system, which can be cost-effective compared to other heat pumps. It may also be suitable for applications where available space is limited, e.g. offshore petroleum installations. The use of R718 as working fluid enables open-loop Mechanical Vapor Recompression (MVR) applications such as direct steam generation to process or drying.

Reference

- Verpe, Espen, Christian Schlemminger, Michael Bantle, and Marcel Ahrens. 2020. "Experimental Evaluation of a Water Based High Temperature Heat Pump with Novel High Pressure Lift Turbo Compressors." <https://doi.org/10.18462/iir.gl.2020.1019>.

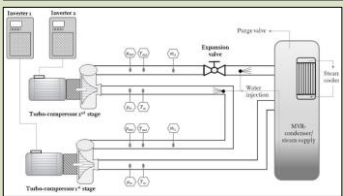

HighEFF goals contribution:



÷ 10 %

Greenhouse gas emissions



÷ 30 %

Specific energy consumption



Increased value creation

Contribution towards HighEFF goals:

Utilization of waste heat to decarbonize industrial process heat through heat pumps reduces GHG emissions. The increased energy efficiency compared to fossil fuel and direct electric heating creates value for the industry.



Cold thermal energy storage (CTES)

Innovation Type:
Technology



Development stage (TRL):

TRL: 4-5

Contact: Ragnhild Sæterli

(Ragnhild.saterli@sintef.no)

Large-scale cold TES for the food industry to balance between high cooling demand and varying availability of low-cost electricity from renewable sources

Challenge

The electricity consumption in the food processing industry is characterised by peaks and valleys due to the throughput of products in energy-intensive refrigeration processes. Refrigeration equipment must be dimensioned according to the maximum load on the warmest day. This strategy results in refrigeration systems that operate on part load for most of the hours.

Solution

A novel CTES unit based on a pillow plate heat exchanger combined with latent thermal energy storage in a phase change material to achieve peak shifting of the refrigeration load. The developed CTES unit can be integrated directly into the refrigeration circuit and can handle the working pressures of CO₂ refrigeration systems (> 70 bar). The temperature which the energy is stored can be varied by changing the phase change material used in the CTES unit. The unit can operate as a thermal battery to store thermal energy at low temperatures (< 0 °C) using the excess refrigeration capacity during the night. During daytime operation, the stored cold thermal energy can be used to unload the compressors and thereby achieve peak shaving of the power consumption. When implementing this technology the refrigeration system can be designed closer to the mean load rather than the peak load, reducing the investment costs of the plant.

Potential

The flexible design of the CTES unit enables dimensioning of the storage to a variety of load profiles in refrigeration systems, shaving peaks with a duration from less than 1 hour up to 5-6 hours. The storage capacity and discharging rate of the CTES unit can be increased by installing more units in parallel and increasing the size of the pillow plate heat exchanger.

Reference

Selvnes, H., Allouche, Y. and Hafner, A., 2021. *Applied Thermal Engineering*, p.117507.

Selvnes, H., Hafner, A. and Kauko, H., 2019. In *25th IIR International Congress of Refrigeration Proceedings*. IIR.

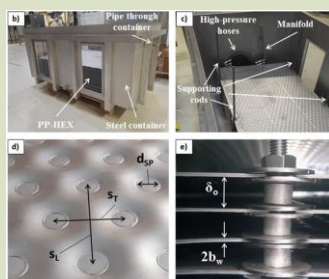

HighEFF goals contribution:



÷ 10 %

Greenhouse gas emissions



÷ 30 %

Specific energy consumption



Increased value creation

Contribution towards HighEFF goals:

CTES reduces peak cooling demands, which enables a reduction in installed capacity and a more efficient operation for the refrigeration system. This reduces both the energy use as well as the operational and investment costs. The reduction in energy use and peak cooling demand is typically in the range of 10 % and 20 %, respectively.



Optimal selection of thermal energy storage technology for fossil-free steam production

Innovation Type:
Methodology



Development stage (TRL):

TRL: 5-6

Contact: Hanne Kauko
(hanne.kauko@sintef.no)

Methodology for identifying the most cost-efficient Thermal Energy Storage (TES) and power-to-heat (P2H) system for load shifting and exploitation of fluctuating renewable energy sources in steam production

Challenge

Steam production is still primarily based on the use of fossil fuels, and all the major industrial energy users devote significant proportions of their fossil fuel consumption to steam production. TES combined with P2H technologies such as electric boilers or high-temperature heat pumps (HTHPs) enables the industries to decarbonize their steam production with rather small changes in the infrastructure, and at the same time shift their energy demands to periods with low electricity prices, thus allowing active participation in renewable-based electricity markets.

Solution

An optimization-based method which helps to select and dimension the cost-optimal TES technology combined with P2H for a given industrial steam process has been developed. The storage technologies considered are latent heat TES, Ruths steam storage, molten salt storage and sensible concrete storage. The method is implemented in Python and uses the steam demand and electricity price profiles as an input to find an optimal TES and P2H combination for the application.

Potential

Steam generation systems were estimated to account for 9% of the global final energy consumption in 2005. Assuming that only 1% of steam demand is stored with a cycle duration of one day, roughly 70 000 steam storages of 100 m³ are required worldwide – and much more, if a shift to renewable-based steam production is desired.

Reference

Beck, A., Sevault, A., Drexler-Schmid, G., Schöny, M., & Kauko, H. (2021). Optimal Selection of Thermal Energy Storage Technology for Fossil-Free Steam Production in the Processing Industry. Applied Sciences, 11(3), 1063.

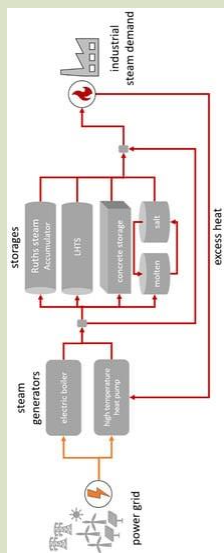

HighEFF goals contribution:



÷ 10 %

Greenhouse gas emissions



÷ 30 %

Specific energy consumption



Increased value creation

Contribution towards HighEFF goals:

High-temperature TES is an important enabler for electrification of fossil-based process heating systems. A 30-40% reduction in GHG emissions was demonstrated in the HighEFF case study on Nidar chocolate factory through combination of P2H and TES. TES allows peak shaving and load shifting, which enables savings in energy costs, but also increased revenues through participation in reserve capacity markets.



Thermal energy storage for improved recovery of industrial waste heat

Innovation Type:
Methodology



Development stage (TRL):

TRL: 5-6

Contact: Hanne Kauko

(hanne.kauko@sintef.no)

Methodology for optimal dimensioning and operation of a thermal energy storage (TES) tank in a district (DH) system based on utilization of industrial waste heat

Challenge

The amount of industrial waste heat available in Europe is estimated to be in the same order of magnitude as the total buildings' heating demand. Many of the waste heat sources are additionally located in areas with high heat demand density, thus suited to be utilized for DH. A major share of industrial waste heat is currently not utilized, e.g. due to geographical and temporal mismatch between the availability of excess heat and the heat demand. Implementation of thermal energy storage (TES) can reduce the peak heating demand in DH systems based on industrial waste heat recovery, thus reducing the costs and emissions for heat production. There is however a lack of efficient approaches for optimal sizing of the TES for a given application, considering variations in the waste heat availability and heat demand.

Solution

A methodology has been developed for optimal sizing and operation of TES for improved waste heat recovery. The method consists of two parts: (1) a simple steady-state algorithm for TES sizing through calculating the reduction in peak heating at different tank sizes; and (2) a dynamic model applying model predictive control (MPC) for detailed simulation of the plant operation at different TES sizes.

Potential

The method is highly applicable to all kinds of waste heat recovery cases, where the waste heat availability and/or heat demand are not constant.

Reference

- Kauko, H., Rohde, D., Knudsen, B. R., & Sund-Olsen, T. (2020). Potential of thermal energy storage for a district heating system utilizing industrial waste heat. *Energies*, 13(15), 3923.
- Knudsen, B. R., Rohde, D., & Kauko, H. (2021). Thermal energy storage sizing for industrial waste-heat utilization in district heating: A model predictive control approach. *Energy*, 234, 121200.

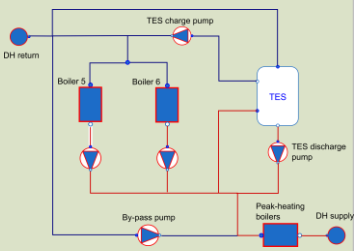

HighEFF goals contribution:



÷ 10 %

Greenhouse gas emissions



÷ 30 %

Specific energy consumption



Increased value creation

Contribution towards HighEFF goals:

Increased utilization of waste heat for DH reduces the use of peak heating sources, thus reducing the costs and emissions of heat production. For the evaluated case of Mo Fjernvarme, the reduction in GHG emissions and heat production costs obtained through TES was 15-20 % and 10-15 %, respectively.





Energy Cascading

Innovation Type:

Concept



Development stage (TRL):

TRL: 4-5

Contact: Halvor Dalaker

(Halvor.Dalaker@sintef.no)

Challenge

Norwegian ferroalloy industry is world leading on energy efficiency and significant efforts are made to further increase the energy efficiency. Production processes based on submerged arc furnaces are energy demanding with about 50 percent of the input energy being provided as electricity. The major part of surplus energy from the production is available as either high temperature (> 500°C) flue gas or as medium temperature (150- 250°C) flue gas with high calorific value (~60 percent CO). Many plants use the energy in the off-gas to produce steam for electricity production. However, the latent heat released in the steam condenser operating at around 45°C is difficult to find use for and represents over 70% of the generated steam energy.

Solution

Biomass drying prior to biocarbon production and amine regeneration in CCS are two examples of energy demanding processes that takes place at moderate temperatures. This makes them ideal candidates for surplus heat utilisation. The high temperature sensible heat in the flue gas can still be used for electricity production. In HighEff, three cases have been compared: 1) Energy recovery with electricity production, 2) Energy recovery with biocarbon production and 3) Energy recovery in carbon neutral production (combining biocarbon production with CCS).

Potential

Simulations indicate that the total energy demand of biomass drying (6MW) and amine regeneration (14MW) can be provided by low temperature steam. This reduces the available thermal energy for electricity production, and the recovered electricity from the steam turbine is reduced from 11 MW down to about 6.5 MW. The total energy demand of the combined process of biochar-production, metal production and carbon capture can be reduced by 16%. By replacing 40% fossil carbon with biocarbon and capturing 90% of the CO₂ emissions the process can be made carbon neutral or even carbon negative.

References

D4.1_2018.02 - Energy cascading within the Ferroalloy industry.

D4.1_2024.07 - Developments in energy optimisation in ferroalloys production

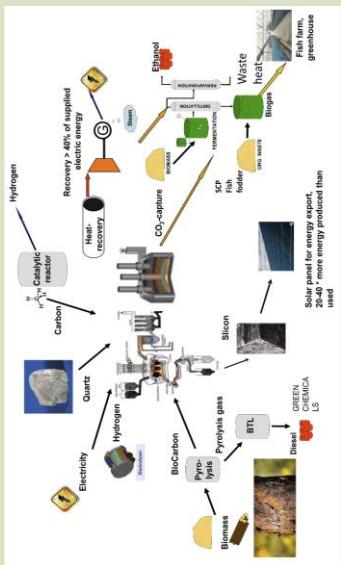

HighEFF goals contribution:



÷ 10%

Greenhouse gas emissions



÷ 30%

Specific energy consumption



Increased value creation

Contribution towards HighEFF goals:

Significant energy efficiency in the ferroalloy industry by utilising surplus heat for energy production, production of biocarbon, CCS etc.





Flue gas recirculation for Silicon Production

Innovation Type:
process
improvements pilot



Development stage (TRL):
TRL-4-5

Contact:
Vegar Andersen
(Vegar.Andersen@elkem.no)

Optimizing flue gas composition for future carbon capture, increased energy recovery and reduced NOx emissions

Challenge

Due to the high temperatures of Silicon process off-gas, increasing CO₂ concentrations in the flue gas by reducing air dilution is limited as heavy off-gas fouling will occur if the flue gas temperature gets too high. Reducing dilution of combustion gasses without increasing flue gas temperature can be achieved by replacing dilution air with recirculated flue gas.

Solution

Mass and energy balance models was used to evaluate the effect of FGR on different process parameters. Small scale lab experiments was conducted to evaluate FGR's effect on microsilica production and a pilot scale test was performed to simulate the combustion process of a real furnace.

Potential

A large pilot-scale experiment of FGR for silicon production has been conducted, demonstrating the concept in close to industrial conditions. Modelling the Si process showed that FGR is an efficient way of increasing the CO₂ concentration in the off-gas, with the benefit of not increasing off-gas temperature. The cost of carbon capture in a conventional scrubber stripper setup was found to be reduced with increasing FGR as higher CO₂ off-gas concentrations allowed for more efficient capture with smaller components and a lower solvent flow, leading to lower specific energy consumption.

Reference

1. Vegar Andersen; Recirculation for the Silicon Process, Doctoral Thesis at NTNU, 2023:135

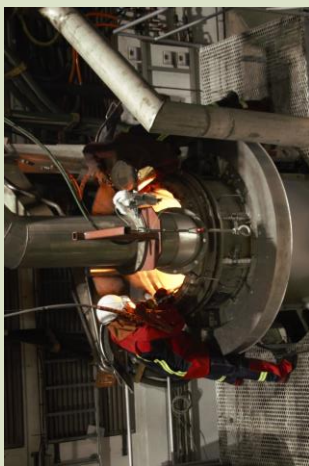

HighEFF goals contribution:



÷ 10 %

Greenhouse gas emissions



÷ 30 %

Specific energy consumption



Increased value creation

Contribution towards HighEFF goals:

The activity has the potential of reducing CO₂ emissions by facilitating Carbon Capture (CCS/U). This technology can eliminate the CO₂ emissions from the silicon process ensuring future production of Si/FeSi and value creation for the industry.





Improving prereduction behaviour to decrease energy and carbon consumption

Innovation Type:
Process



Development stage (TRL):
TRL: 2-3

Contact:
Trygve Lindahl Schanche
(trygve.lindahl.schanche@sintef.no)

The ore-gas reactions occur in today's process at a temperature range favoring the occurrence of the Boudouard reaction causing increased energy and carbon consumption. It further leads to a high-energy off-gas rich in CO(g).

Challenge

The ore-gas prereduction reactions in ferromanganese production are well-known to be governed by kinetics and dependent on the characteristics of the manganese ores. Due to complex and multistep reaction schemes, in addition to a high number of commercial manganese ores, the behaviour of the ores in the furnace is not well understood. Promoting optimal reduction while still maintaining operational requirements (e.g. ore size due to decrepitation and fines generation during heating) is thus a complex affair.

Solution

Tailoring the sizing and feed location of the ores:

Size requirements for the ores may be specific for the given ore. Ores are less/more sensitive towards decrepitation, and the reaction rate is more/less promoted by the ores' particle size, so an optimum size range exist for each ore.

Introduction of pretreatment unit:

Utilization of the high-energy off-gas may be utilized through a pretreatment unit. This may also decrease the occurrence of the Boudouard reaction, as well as giving increased stability of the furnace, both resulting in lowered energy and carbon consumption. This is now currently being investigated in the EU HORIZON 2020 PREMA project, where data obtained in HighEFF is used to determine optimum conditions of such a unit.

Potential

Mass and energy balances show that the Boudouard reaction may typically consume 15-25% of the total energy consumption in production of HC FeMn alloys.

Reference

Larsen, T. A. (2020). Prereduction of Comilog-and Nchwani ore. Dr. Ing thesis, NTNU.

HighEFF goals contribution:



÷ 10 %

Greenhouse gas emissions



÷ 30 %

Specific energy consumption



Increased value creation

Contribution towards HighEFF goals:

The Innovation can reduce the energy consumption by 15-25%. This will increase the value creation for the industry.

HighEFF



Novel heat recovery concept for aluminium smelter off-gas

Innovation Type:
Component



Development stage (TRL):
Approaching TRL 5

Contact: Magnus Windfeldt
(magnus.windfeldt@sintef.no)

Challenge

The gas produced during electrolysis of aluminium contains an enormous amount of surplus heat which is very rarely utilised. A major reason for this is the "hard grey scale" (HGS) that forms on surfaces in contact with the gas. This causes clogging and equipment damage. Current commercial solutions for heat recovery are very bulky and costly, and therefore implemented to a very small degree in the industry.

Solution

A novel plate-based heat exchanger concept has been developed with a geometry theorised to be resistant to the formation of HGS. Simulation work has shown a potentially large reduction in both size and weight compared to commercial solutions, indicating a significant reduction in manufacturing cost. A prototype heat exchanger has been constructed and is under installation in a gas duct at Alcoa. It will be tested both for resistance to HGS formation and heat transfer performance compared to model predictions.

Potential

It has been estimated that around 1 TWh/y of surplus heat leaves Norwegian aluminium plants in the off-gas. Thus, enabling cost efficient heat recovery can unlock a significant energy source for local use. If the concept is proven resistant to HGS formation, the heat can even be recovered prior to gas cleaning where temperatures are significantly higher, which would open for additional applications for the recovered heat. While the aluminium industry itself has limited use for heat as a process input, research efforts in HighEFF have shown many external use cases for value creation enabled by the use of this heat.

Reference

D4.2_2019.01, D4.2_2020.01, D2.1_2020.01, D3.1_2020.03, D4.2_2021.01, D4.2_2022.01

Skjervold V., Skaugen G., Andresen T., Nekså P., *Enabling power production from challenging industrial off-gas – model-based investigation of a novel heat recovery concept.*, IIR Rankine Conference 2020 <http://dx.doi.org/10.18462/iir.rankine.2020.1145>.

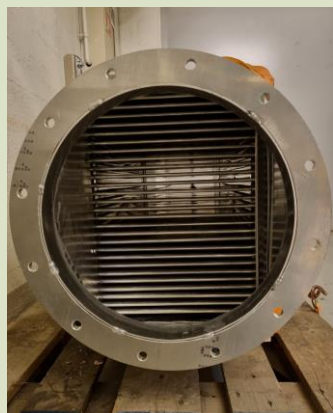

HighEFF goals contribution:



÷ 10 %

Greenhouse gas emissions



÷ 30 %

Specific energy consumption



Increased value creation

Contribution towards HighEFF goals:

This novel heat recovery concept could if proven become a key enabling technology for unlocking around 1 TWh/y of surplus heat as a usable energy source.



Assessment method for thermal energy storage sizing with variable surplus heat streams

Innovation Type:  Methodologies

Development stage (TRL): TRL 5

Contact: Brage R. Knudsen (brage.Knudsen@sintef.no)

Challenge

Thermal energy storage (TES) is a key technology for enabling increased utilization of industrial waste heat in district heating. The ability of TES to equalize offsets in demand and supply depends strongly on the sizing, control and integration in a heating plant.

Solution

We propose to evaluate the effective peak-heating reduction with different TES sizes and the energy-to-heat-flow-ratio for the TES discharging periods as performance metrics. Either simplified static or more advanced dynamic models may be used.

Potential

- Make operators (including district heating) of surplus heat utilization able to fast-track sizing of thermal energy storage to better utilize variable waste heat.
- Reduce use of polluting and costly peak heating sources to cover peak demand by enabling optimal sizing of TES in terms of delivering energy and heat duty (thermal power)
- Surplus heat utilization is becoming increasingly important; more actors will face similar challenge, thus the upscaling potential in use of method is significant.

Reference

<https://doi.org/10.1016/j.energy.2021.121200>
[10.3390/en13153923](https://doi.org/10.3390/en13153923)

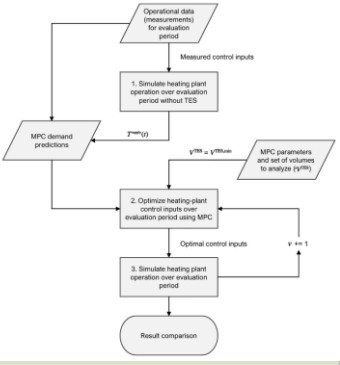

HighEFF goals contribution:

- ÷ 10 %**
Greenhouse gas emissions
- ÷ 30 %**
Specific energy consumption
- 
Increased value creation

Contribution towards HighEFF goals: 

Depends on case. For Mo Fjernvarme, our results suggest that a modest TES tank volume of 1500 m3 is sufficient to achieve a half-year peak-heating reduction of 12% and comparable performance with larger volume





Novel perspectives on barriers and enablers

Innovation Type:
Organisation



Development stage (TRL):
Ready for further use by policy makers, regional public actors and firms

Contact: Jens Røyrvik
jens.royrvik@ntnu.no

Challenge

Potentials and barriers Identifying and matching heat sources with possible heat users is not straightforward. There is a need for available databases of surplus heat sources in Norway, and to connect these to heat users.

Solution

Based on extensive document analyses, interviews of industry, research and political actors, media analyses, industry visits, workshops and more, specific policy recommendations are proposed:

- Consider local by-product exchanges when localizing new industry plants
- Evaluate surplus heat by-products beyond organizational boundaries
- Company-community interactions should take place at multiple levels
- Networks and trust reduces collaboration barriers towards CE
- Consider different modes of valuation for circulation principles

Potential

Involvement of policy makers, regional public actors and firms, is essential to unleash the potential for surplus heat utilization.

Further related HighEFF work

- Insights into potentials and barriers informs wide range of social scientific research in HighEFF.

Reference

- Røyrvik, J., & Johansen, J. P. 2020. D5.1_2020.01 Barriers and enablers. Policy brief. FME HighEFF Centre for an Energy Efficient and Competitive Industry for the Future

HighEFF goals contribution:



÷ 10 %

Greenhouse gas emissions



÷ 30 %

Specific energy consumption



Increased value creation

Contribution towards HighEFF goals:

The innovation supports reduced energy consumption through increased surplus heat utilization.





Resource and energy collaborations handbook

Innovation Type:
Model



Development stage (TRL):
Ready for further use by policy makers, regional public actors and firms

Contact: Catharina Lindheim
(catharina.lindheim@samforsk.no)

Challenge

Industries often have surplus energy or other resources that go unused.

Solution

The handbook aims to inspire businesses on the supply side form new collaborations around surplus energy. Factors increasing the likelihood of success include culture and values, innovative environments, and external relations. The handbook suggests tips and ideas to increase the profitability of energy collaborations and considers all stages of the collaboration process: Before, during establishment, after establishment, and throughout the process. Examples include:

- Develop a common understanding of different parties’ needs, aims, possibilities, visions, timeframes
- Be aware of the timing and interdependency of different parties’ decision points and deadlines
- Understanding, commitment, anchorage at every level of the organisation
- Engage in a dialogue with municipality and other relevant actors

Potential

Business partnerships can prevent these resources from going to waste, improve their competitiveness and help Norwegian industry increase its energy efficiency and reduce its environmental impact.

Reference

- Lindheim, C., Liste, L., & Albert, D. 2021. Resource and Energy Collaborations – a Handbook. NTNU Social Research.

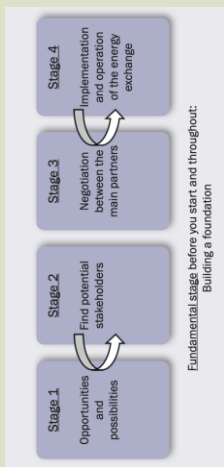

Important stages in energy collaboration processes

HighEFF goals contribution:



÷ 10 %

Greenhouse gas emissions



÷ 30 %

Specific energy consumption



Increased value creation

Contribution towards HighEFF goals:

The innovation can be used to support novel business partnerships thereby reducing resource waste, improving value creation, and reducing environmental impacts.





DigiHP - Towards digitalization of heat pumps by using ML and IoT for optimal operation

Innovation Type:
Modeling Concept



Development stage (TRL):
Need to be tested.

Contact: Cansu Birgen
(cansu.birgen@sintef.no)

Challenge

Developing a good model for predicting COP can help to achieve optimal operation by understanding the influence of key parameters on the performance. Existing method for estimating COP uses sensor data to measure the heat supplied by the heat pump and the power consumption that is dependent on the heat pump components as well as heat/cold source and delivery requirement e.g., setpoint temperature. An alternative approach could be to develop a data-based model to predict the COP based on these environmental parameters that would inherently capture the interaction between the components of the integrated system.

Solution

Develop a data-based, machine learning, model to predict COP based on environmental parameters which in return could be used in optimizing the operation, thus increasing the efficiency, at the same time using digitalization tools to increase the competitiveness of industry.

Potential

Estimation of COP beforehand using environmental parameters that are readily available e.g. weather forecast.

Estimated COP can be utilized for process optimization and control by altering algorithms and/or operating parameters.

In case of failure of sensors to calculate COP, trained machine learning model can be used to predict COP values based on environmental parameters.

Reference

[1] Yu H., Khan F., Garaniya V. (2016) A sparse PCA for nonlinear fault diagnosis and robust feature discovery of industrial processes. *AIChE J.*; 62(5):1494–513.

[2] Birgen, C., Magnanelli, E., Carlsson, P., Skreiberg, Ø., Mosby, J., & Becidan, M. (2021). Machine learning based modelling for lower heating value prediction of municipal solid waste. *Fuel*, 283, 118906.

HighEFF goals contribution:



÷ 10 %

Greenhouse gas emissions



÷ 30 %

Specific energy consumption



Increased value creation

Contribution towards HighEFF goals:

The DigiHP concept will help to operate heat pumps with higher certainty and perform optimization with a predetermined efficiency parameter of COP in addition to the failure detection that would increase the deployment.

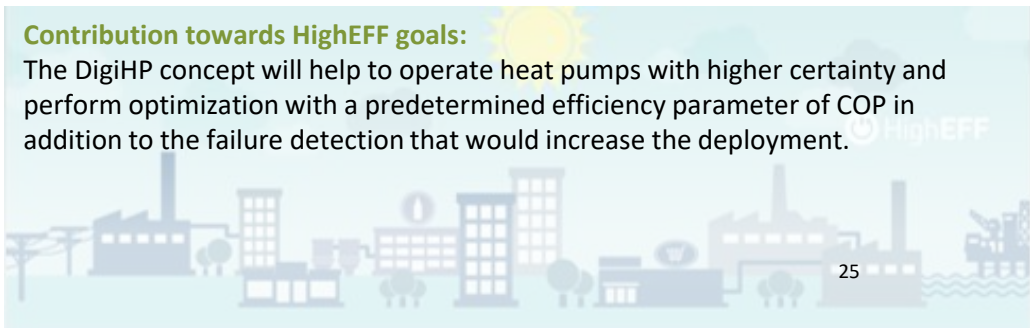



HighEffEC: Reduction of CO₂ emissions from industrial processes through integration of high-efficiency H₂O/CO₂ electrolysis

Innovation Type:
Model, new application, process



Development stage (TRL):
TRL 2-3 Concept development

Contact: Gonzalo del Alamo
(Gonzalo.alamo@sintef.no)

Challenge

The production of manganese, a key component in iron and steel production, has typical GHG emissions of 1.4 tonne CO₂ per tonne manganese alloy. Conventional routes for reducing CO₂ emissions in manganese production via CO₂ capture using amine-based solvents are expensive leading to an increase in the cost of manganese production cost of above 100 \$/tonne. Therefore, developing manganese production processes that can reduce the cost of reducing CO₂ emissions are needed.

Solution

The HighEffEC project explores the potential of a novel process concept to reduce the cost of decarbonizing the manganese production process, which involves integrating fuel-assisted solid oxide electrolysis cells (FASOECs) into a two-stage scheme for the reduction of raw manganese ores. The off-gas from the manganese ores after reduction is either fully or partly supplied to the FASOECs as fuel to produce hydrogen that is subsequently directed to the first stage of manganese reduction. This concept reduces the generation of CO₂ in the overall reduction of manganese oxides, due to lower coke consumption, and reduces the cost of decarbonization by separating directly the CO₂ at the exhaust of the FASOEC.

Potential to contribute towards HighEFF goals

The HighEffEC project demonstrates that directing the full supply of off-gas produced by the SAF at 800°C to the FASOECs decreases the cost of decarbonization by as much as 3-15% in comparison to conventional manganese production processes, with a corresponding decarbonization price range of \$4-32 per ton of manganese product for plant capacities of 50 and 200 kt, respectively

Reference

G. del Alamo, A. S. Nielsen, T. L. Schanche, and O. Burheim, "Reducing CO₂ emissions and decarbonization costs in manganese production by integrating fuel-assisted solid oxide electrolysis cells in 2-stage oxide reduction," submitted to Applied Energy

HighEFF goals contribution:



÷ 10 %

Greenhouse gas emissions



÷ 30 %

Specific energy consumption



Increased value creation

Contribution towards HighEFF goals:

This concept reduces can contribute to the reduction of Greenhouse gas emissions by 7.6% of CO₂ and to reduction of electricity used by 18.2%.

HighEFF





INTERCUR – Integrated Energy Systems for Industrial Clusters

Innovation Type: **Model** 

Development stage: **First version available**

Contact: Truls Flatberg
Truls.Flatberg@sintef.no

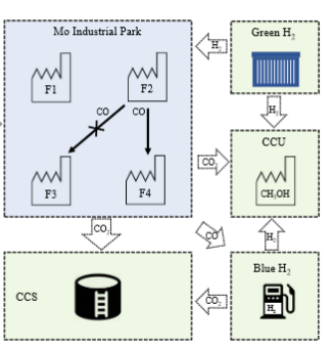

Challenge

Evaluating investment possibilities within an industrial cluster presents several complex challenges that require careful consideration from both economic and environmental perspectives. Clusters should explore circular economy principles, considering not only production but also product use, surplus heat, recycling, and waste management. This shift toward sustainability demands innovative thinking.

Solution

INTERCUR is a steady-state optimization model developed for the total annual cost optimization of industrial clusters. The model places a strong emphasis on **combined resource and energy conservation**, aiming to identify **low-hanging integration opportunities** that yield both **financial and environmental benefits**. The model treats both material and energy flows and uses concepts from pinch analysis to calculate the surplus heat available for the given temperatures. INTERCUR is designed for active use in the decision-making processes. It achieves this by identifying potential new partners or investment opportunities that can either benefit from or contribute to existing synergies within the industrial cluster. The model's effectiveness has been validated through relevant case studies, particularly in the context of an eco-industrial park in Norway.

Potential

INTERCUR, when systematically evaluating investment possibilities within an industrial cluster, can act as a catalyst for embracing novel technologies and showcasing the advantages of investing in new projects or engaging new partners. By consistently applying this approach to compare various projects and alternatives, industrial clusters can effectively prioritize activities that yield the most significant impact, both economically and environmentally.

HighEFF goals contribution:

- ÷ 10 %**
Greenhouse gas emissions
- ÷ 30 %**
Specific energy consumption
- 
Increased value creation

Contribution towards HighEFF goals: 

The INTERCUR model represents an enabling innovation. As a versatile tool, it allows for the evaluation of novel ideas and investment opportunities that give impacts within all HighEFF goal categories when applied within an industrial cluster.





Digital twin for additive manufacturing of heat exchangers

Innovation Type:
Model



Development stage (TRL):

TRL: 3-4

Demonstrated in laboratory

HighEFF activity:

NEC HighEX

Contact: Trond Andresen
(trond.andresen@sintef.no)

Challenge

Additive manufacturing can process complex geometries at no additional cost, and realize geometries unachievable by conventional manufacturing technologies. However, the AM process itself subjects the product to large thermal stresses that is likely to cause deformations larger than we can tolerate.

Solution

The developed numerical workflow predicts thermal distortion from the AM process and allows the 3D-model to be compensated accordingly. This way, the thermal deformations during manufacturing gives the overall intended geometry.

Potential

This mitigates an important barrier for AM-production of functional and high-performing heat exchangers, and is an enabler for development and realization of new generations of highly effective heat transfer solutions.

Reference

1. Deliverable D5.2_2020.04 "NEC HighEX - Design for additive manufacturing of novel heat exchangers"
2. Blog: "Additive manufacturing of heat exchangers (How would it work?)"

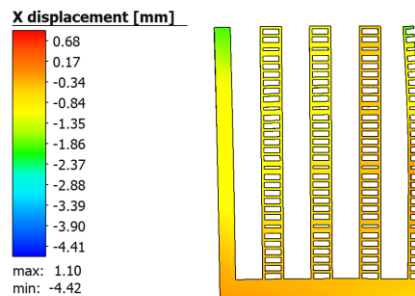
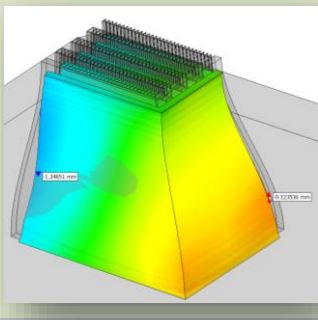

Predicted thermal distortion

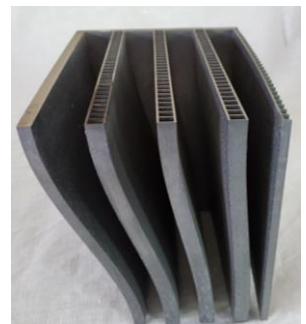

Produced sample geometry for validation

HighEFF goals contribution:



÷ 10 %

Greenhouse gas emissions



÷ 30 %

Specific energy consumption



Increased value creation

Contribution towards HighEFF goals:

This innovation is considered an enabler for component development generally, and novel heat exchanger concept particularly.

Industrial use of heat exchangers is extremely widespread, therefore large energy-related improvement impact can come from both incremental improvements to wide-spread solutions, as well as novel, disruptive improvement to more niche applications.

HighEFF



Next Generation Casting Process for the Ferroalloy Industry

Innovation Type:
Concept, Process, and Model



Development stage (TRL):
TRL: 2

Contact: Ida T. Kero
 (ida.kero@sintef.no)

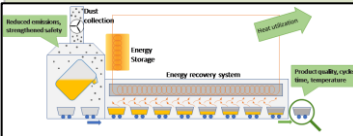

Challenge

The heat losses from the casting of metals constitute the second largest energy loss in a typical ferroalloy or silicon smelter. Hence, the casting process is very interesting as a potential source of surplus energy recovery. It is particularly interesting to recover this heat because of the very high temperatures (ca. 1500°C). However, casting is a batch process, which means it is somewhat challenging to recover and use the energy efficiently. Hence, a thermal energy storage unit is included in the NECast concept.

Solution

NECast- an energy recovery system integrated in a novel casting process with improved dust abatement, product quality, health, safety and environment.

Potential

The potential savings in Norway per year are: 120GWh electricity, which corresponds to 1,5% less electricity bought from the grid. Alternatively, if used as heat: 400 GWh which corresponds to the annual energy required to heat > 35 000 houses in Norway. (Calculated based on numbers from 2014 for total Norwegian ferroalloy production [Nedkvitne, 2014]). Other potential benefits with the NECast system include: reduced energy use, improved product control, reduced material losses (fines and dust), reduced diffuse emissions to the outer environment, improved occupational hygiene (indoor air quality), increases automation and digitalisation, and improved occupational safety.

Reference

NECast final report by Andresen, Skjervold, Kero and Gouttebroze 2021.
 HighEFF deliverable D5.2_2021.06

HighEFF goals contribution:

- ÷ 10 %**
Greenhouse gas emissions
- ÷ 30 %**
Specific energy consumption
- 
Increased value creation

Contribution towards HighEFF goals: 

If the energy is used as heat, no emission reduction is achieved. If the energy is used as electricity, the emission reduction depends on the electricity mix replaced.



29



NEIC Biochar 1 & 2

Innovation Type:
Process Concept



Development stage (TRL):

3

Contact: Samuel Senanu

(samuel.senanu@sintef.no)

Challenge

Increased use of biocarbon from sustainable sources will help the metal industry to achieve carbon neutrality and in the best-case scenario, carbon negativity when combined with CCSU. However, current outlooks suggests there is not enough biocarbon sources from forest reserves to satisfy the needs of the metal industry. Seaweed, especially kelp, cultivated in sea farms along the Norwegian coast provide a promising opportunity for a sustainable alternative source of biocarbon for the metal industry specifically the ferroalloy industry. Also, the surplus heat can be utilised for drying. However, little research has been done on biochar from seaweed for application in the ferroalloy industry.

Solution

Conduct a thorough methodological research that investigates the feasibility of using kelp biochar in the metal production. Focus for research should include processing, characterisation and feasibility studies as described in the figure below.

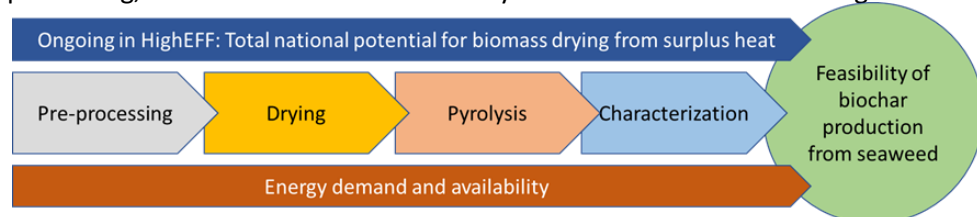

Potential

Kelp biochar as a reductant will help reduce CO₂ footprint of the metal industry. CO₂ sequestering through seaweed farming by ca. 284 Kt annually
Utilisation of 1430 GWh of surplus heat from metallurgical industry in Norway

Reference

1. Process21 report – "Ny prosessteknologi med redusert karbonavtrykk inkl. CCU"
2. Broch et al., 2019. <https://www.frontiersin.org/articles/10.3389/fmars.2018.00529/full>
3. Windfeldt et. al. 2022. "CO₂ uptake potential with seaweed drying using surplus heat from metallurgical industries" High Annual consortium meeting, May 2022.

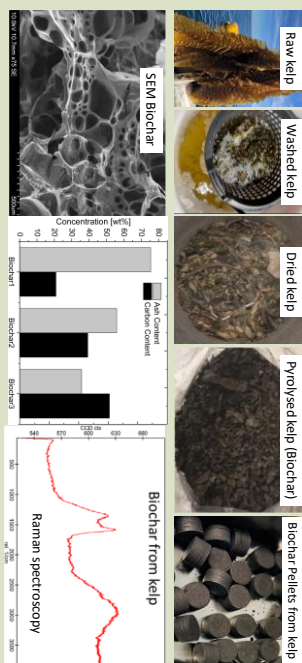

HighEFF goals contribution:



÷ 10 %

Greenhouse gas emissions



÷ 30 %

Specific energy consumption



Increased value creation

Contribution towards HighEFF goals:

The introduction of kelp biochar as a feasible biocarbon material for metal production will reduce fossil CO₂ emission. The need for drying the seaweed will enable the utilisation of surplus heat from the metal industry contributing to value creation.



ITChES – Integration of ThermoChemical Energy Storage

Innovation Type:
Concept
 Process, and Model



Development stage (TRL):
TRL: 3

Contact: Jorge Salgado Beceiro
jorge.beceiro@sintef.no

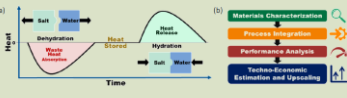
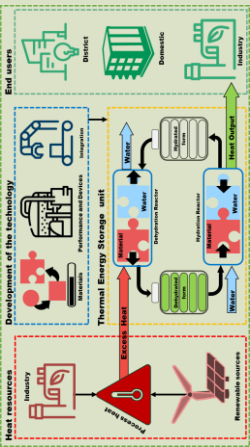

Challenge

Developing flexible technologies for excess heat recovery and storage is crucial for energy efficiency in industry. Water-sorption TCES systems offer promise but are still at a low technology readiness level. Unlike phase change materials, TCES enables loss-free, long-term storage at room temperature with higher energy density. Current research focuses on material properties, lacking lab-scale validation. Our goal is to validate materials at lab scale to advance industrial uptake, with compounds like $MgCl_2$ needing further study. Lab-scale characterization aims to pave the way for upscaling and integration, offering economic potential by enhancing heat capacity without increasing reactor size.

Solution

ITChES aims to select materials for excess heat recovery through thermo-chemical analysis. It will then conduct performance analysis of selected materials in a lab-scale reactor to develop an integration and techno-economic study for upscaled SA-TCES systems.

Potential

A number of HighEFF partners, including Hydro, Equinor, Eramet, and others, have shown interest in TCES implementation, recognizing its potential to enhance heat system flexibility and efficiency. Addressing just 10% of Norway's yearly 20 TWh of industrial waste heat with TCES could represent a market opportunity of €1.2 billion by 2030. Infracapital projects the global market for TES technologies, including TCES, to exceed €300 billion by 2030, with TCES uniquely positioned for long-term storage applications.

Reference

- Salgado-Beceiro, Jorge, et al. "Thermochemical Energy Storage: an approach to integration pathways." *8th International Conference on Smart and Sustainable Technologies (SpliTech)*. IEEE, 2023.
- Salgado Beceiro, J., & Kjæstad Sæterli, R. Thermochemical Energy Storage: The next generation thermal batteries? #SINTEFblogg, 2022.

HighEFF goals contribution:

- ÷ 10 %**
Greenhouse gas emissions
- ÷ 30 %**
Specific energy consumption
- Increased value creation

Contribution towards HighEFF goals:

TCES supports HighEFF goals by decoupling energy production and consumption, enabling integration of renewable sources, utilizing industrial excess heat, and optimizing auxiliary equipment operation.





PrintUP – 3D-printed ejector parts

Innovation Type:
Technology



Development stage (TRL):
4-5

Contact: Krzysztof Banasiak
(krzysztof.banasiak@sintef.no)

Challenge

Additive manufacturing, as replacement for traditional and costly manufacturing technologies, is seen as a key in developing more efficient components for heat pumps and refrigeration systems like ejectors, due to the flexibility of geometries and cost that can be reached. However, performance of an ejector is very sensitive to the quality of the surfaces interacting with the refrigerant. Also, the 3D-printed parts must get efficiently embedded in a bigger system. Reaching requested dimension tolerances and surface roughness after the 3D-printing process might entail extra manufacturing costs that could make the 3D technique not economically viable.

Solution

- CFD-based optimization of the ejector geometry.
- Proper selection of construction material (thermal/mechanical/chemical constraints imposed by the heat pump or refrigeration system).
- Cross-checking of the available 3D printout quality (tolerances/surface roughness) vs. mechanical specification of the ejector assembly interfaces.
- Manufacturing process (3D-printing) and ejector integration in the system.
- Experimental validation at laboratory test rig.

Potential

Unlimited use of CFD techniques to ejector geometry optimization, both upgrade of the existing designs and brand new concepts.

Reference

Knut Emil Ringstad, CFD Modelling for Improved Components in CO₂ and Ammonia Vapour Compression Systems, Doctoral thesis, Institutt for energi og prosessteknikk, NTNU, 2023. URL: <https://hdl.handle.net/11250/3068650>



HighEFF goals contribution: ✓



÷ 10 %

Greenhouse gas emissions



÷ 30 %

Specific energy consumption



Increased value creation

Contribution towards HighEFF goals:

Effective 3D printing of ejector geometries is considered an enabling innovation. It may be applied as an innovative approach towards efficiency improvements and manufacturing cost reductions that give impacts within heat pump and refrigeration sector.

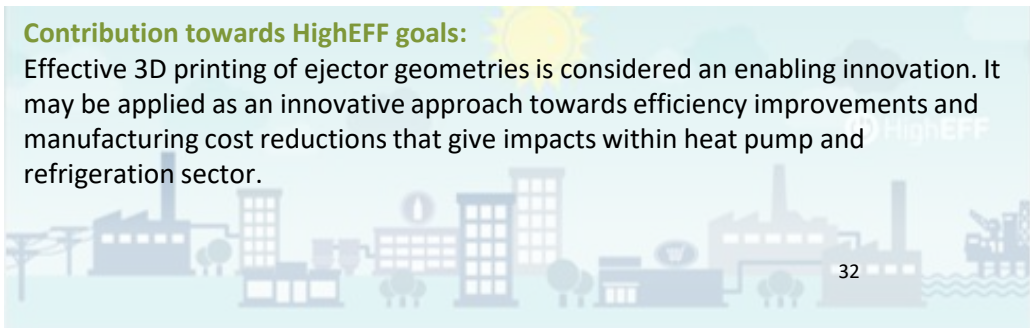



SOCTES

Innovative State-of-charge and Output Control of PCM-TES systems

Innovation Type:
Methodology
Components



Development stage (TRL):
TRL: 4

Contact: Magnus Rotan
magnus.rotan@sintef.no

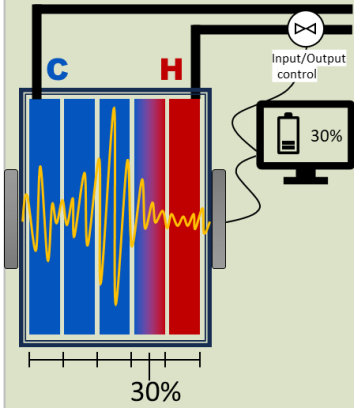

Challenge

Thermal energy storage (TES) based on phase change materials (PCM) is a key enabler for increased energy efficiency and flexibility in the industry and is receiving considerable attention as seen by the increased research and development of innovative technologies in the field. Though essential for industrial operations, solutions for reliable control of PCM-TES systems have so far not been realised. In SOCTES, the aim is to validate and implement real-time state-of-charge monitoring and heat output control methods for PCM-TES systems, enabling optimal energy utilization and reliable heat (or cold) supply.

Solution

In SOCTES the possibility to use ultrasound to determine state-of-charge (SoC) is explored. Coupled with a control algorithm using reinforcement learning the charge and discharge of the TES is optimized for relevant energy systems. Existing methods to measure and monitor the SoC of a PCM-TES unit include measuring temperature at several locations, heat flows through the heat exchanger (HX) or volumetric change of PCM during the transition phase from solid to liquid or liquid to solid. However, these methods are either complex in practice or do not provide precise information on the near-isothermal phase change progress, which is an issue after several consequent partial charges and discharges. By use of ultrasound and signal processing the ratio of liquid and solid and hence the SoC can be determined with higher accuracy. This enables a steadier output of the PCM-based TES and hence it becomes more reliable. Coupled with a heat pump it provides additional benefits as a constant input for the heat pump enables it to operate in a cost-efficient way.

Potential

The UK company Infracapital has estimated the global market for TES technologies to be €300+ billion by 2030. Implementing this technology in PCM-based TES creates better perspectives for successful deployment of TES in energy systems. New projects are directed for further development of the concept and a patent is pending.

HighEFF goals contribution:



÷ 10 %

Greenhouse gas emissions



÷ 30 %

Specific energy consumption



Increased value creation



Contribution towards HighEFF goals:

Considering 20TWh of excess heat wasted from Norwegian Industry, the potential for energy savings are huge. TES plays a crucial role for utilization of the excess heat and the implementation of precise SoC determination and stable heat flows enables a more reliable investment for the stakeholder.



TES-AC Demo-prosjekt REMA 1000 Orkidéhøgda

Innovation Type:
New application
Process, technology

Development stage (TRL):
TRL: 5-6

Contact: xx
 (hagar.elarga@sintef.no)

Challenge

Electricity and power systems may become unacceptably unreliable during peak demand. On the other hand, the peak demands are directly coupled to the thermal cooling sources, i.e. heat pump. The main challenge is to shift this peak load efficiently by utilizing thermal energy storage technology that developed at HighEFF.

Solution

The NEIC project demonstrates and analyses an innovative TES technology“ developed in HighEff” integrated into the REMA1000 refrigeration system and utilized to meet the supermarket AC loads in the summer season.

Potential

- The expected value energy savings = 20% due to the day/night electricity price variation
- 13-19% peak power reduction

Reference

-Selvnes, H., Pardiñas, Á. Á., & Hafner, A. (2023, April27). Cold thermal energy storage for air conditioning in a supermarket CO2 booster refrigeration system. 10th IIR Conference:Ammonia and CO2 Refrigeration Technologies,Ohrid, North Macedonia.<https://doi.org/10.18462/IIR.NH3-CO2.2023.0021>

-Selvnes, H., Sevault, A., Elarga, H., Hafner, A., (2024, 6June)Demonstration of cold thermal energy storage for air-conditioning in a CO2 supermarket refrigeration system. ENERSTOCK 2024 The 16th IAE EST CP International Conference on Energy Storage, Lyon, France

HighEFF goals contribution:

<input type="checkbox"/>	÷ 10 % Greenhouse gas emissions
<input checked="" type="checkbox"/>	÷ 30 % Specific energy consumption
<input checked="" type="checkbox"/>	 Increased value creation

Contribution towards HighEFF goals:

- 1- Load shifting to the night " during charging" shall increase the value creation of the complete AC system
- 2- Shift peak load by 13 to 19% " Power grids and suppliers imposes extra fees for peak power consumption)

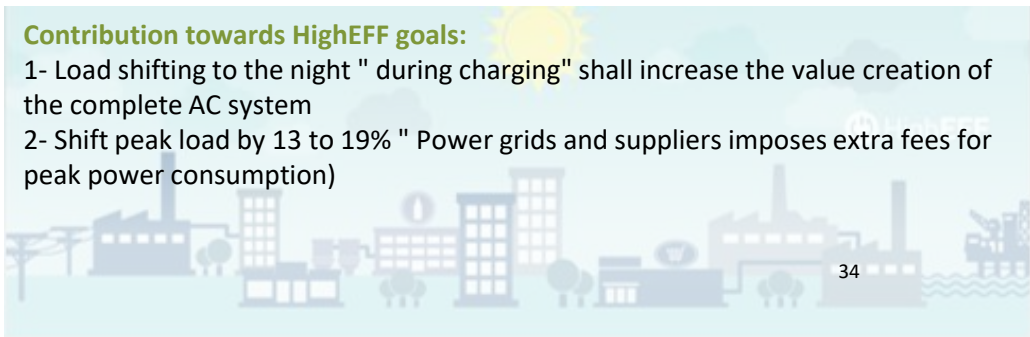



Innovation Type:
Process
Technology

Development stage (TRL):
6-7

Contact: Egil Skybakmoen
(egil.skybakmoen@sintef.no)

Pre-heating of anodes in primary production of aluminium

Challenge

In the Hall-Héroult process for Al production, new anodes are inserted to the electrolytic cell at room temperature, while spent anodes are removed and set aside to cool down. Newly inserted anodes will not produce metal until they reach an adequate temperature. The heating of new anodes in the cell consume significant amounts of energy.

Solution

New anodes can be pre-heated using the using spent anodes residual heat.

Potential

Productivity can be increased by 1 % while energy consumption can be decreased by 0.2 %. This would translate to a global energy saving potential of 7.8 TWh per year.

Increased productivity is based on literature data (Fortini et al., Light Metals 2012, pp. 595-600) achieved over a longer operating period. Achieved reduced energy consumption is based upon succesful heating to 150°C using spent anode butts, while the potential of 7.8 TWh requires heating up to 960 ° C, assuming an average energy consumption of 12 kWh/kg-Al and 65000 metric tonnes produced.

References

Martin Grimstad, NTNU. M.Sc.Thesis. 2009: Using Surplus Heat to Pre-Heat Carbon Anodes for Aluminium Electrolysis.

Grimstad, Eldstad, Solheim and Einarsrud: "Utilization of waste heat for pre-heating of anodes." Light Metals 2020. Springer International Publishing, 2020. 811-816.

HighEFF goals contribution:

- ÷ 10 %**
Greenhouse gas emissions
- ÷ 30 %**
Specific energy consumption
- Increased value creation

Contribution towards HighEFF goals:
0.2 % lower energy consumption



Innovation Type:
Concept
Process

Development stage (TRL):
7-8

Contact: **Ida T. Kero**
(ida.kero@sintef.no)

Electricity generation from CO-rich off-gas from ferroalloy production

Challenge

The off-gas from Manganese ferroalloy production in sealed furnaces contains burnable gases, most notably carbon monoxide (CO). The gas has traditionally been flared.

Solution

The burnable gases can fuel a gas engine to generate electricity. (After combustion, heat recovery is also possible).

Potential

At the Eramet Norway smelter in Sauda, 133 GWh of electricity could be generated annually. This would reduce the electricity bought from the grid could 18%.

Reference

Ida T. Kero, Halvor Dalaker, Silje Fosse Håkonsen, Trine A. Larsen and Roger Khalil: Potential uses of CO-rich off-gas from Mn ferroalloy production. SINTEF Report 2018:00171. HighEFF Deliverables D6.1_2018.01 and D6.1_2021.01

HighEFF goals contribution:

<input type="checkbox"/>	÷ 10 % Greenhouse gas emissions
<input checked="" type="checkbox"/>	÷ 30 % Specific energy consumption
<input type="checkbox"/>	 Increased value creation

Contribution towards HighEFF goals:
18 % less electricity bought from grid



Innovation Type:
 Concept
 Process
 Technology

Development stage (TRL):
 The prereduction in a separate unit has been developed to TRL 6-7 through the EU project PreMa.
 Drying and pre-heating is industrially implemented now.

Contact: Ida T. Kero
 (ida.kero@sintef.no)

Drying, preheating or prereduction of Mn ores using CO-rich off-gas

Challenge

The off-gas from Manganese ferroalloy production in sealed furnaces contains burnable gases, most notably carbon monoxide (CO). The gas has traditionally been flared. More recently, the gas is used as fuel - either inhouse (e.g. for electricity production) or externally (e.g. sold to neighboring industries as furnace fuel). However, the CO could be a valuable chemical (e.g. a reducing agent).

Solution

The energy in the CO-rich furnace off-gas from manganese ferroalloy production* can be combusted and the heat thus produced can be used to dry and preheat raw materials. This would be particularly beneficial for the ores with a moisture content of 5-10%. The CO-rich furnace gas* can also be used to pre-reduce manganese ores in a separate pretreatment unit.

Potential

Drying and preheating of an example ore mixture* to 400 °C can reduce the energy consumption in the submerged arc furnace (SAF) by 19%. CO₂ equivalents can be lowered by 4.5%**. Prereduction of an example ore mixture* can reduce the energy consumption by 19%. It can reduce direct CO₂-emissions by 9%, and overall CO₂-emissions by 12%**.

*Energy consumption in FeMn-production is dependent on the type of ores used. The values presented here were estimated for a mix of 50 % Comilog ore + 50 % Nchwaning ore. Savings are relative to average energy consumption in Norwegian HC FeMn production.

**Assuming average European energy market mix

Reference

Ida T. Kero, Halvor Dalaker, Silje Fosse Håkonsen, Trine A. Larssen and Roger Khalil: Potential uses of CO-rich off-gas from Mn ferroalloy production. SINTEF Report 2018:00171. HighEFF Deliverable D6.1_2021.01

HighEFF goals contribution:

- ÷ 10 %**

Greenhouse gas emissions
- ÷ 30 %**

Specific energy consumption
- 

Increased value creation

Contribution towards HighEFF goals: 

See estimated values above





Innovation Type:
New application
Process

Development stage (TRL):
WGS for H₂ production: 5
Use off-gas as feedstock: 2

Contact: **Ida T. Kero**
 ida.kero@sintef.no

H₂ production from CO-rich off-gas

Challenge

The off-gas from Manganese ferroalloy production in sealed furnaces contains burnable gases, most notably carbon monoxide (CO). At the Ferroglobe smelter in Mo i Rana, Norway most of the gas is sold to neighbor industries for furnace heating. However, about 10-15% of the gas is flared.

Solution

Use CO-rich off-gas to produce hydrogen through the water gas shift (WGS) reaction.

Potential

The portion of the gas which is currently flared at Mo Industrial Park could, under ideal conditions, produce enough hydrogen to power 36 city buses per year; eliminating approximately 3600 tons of CO₂-emissions.

Currently, about 10-15% of the gas is flared and most of the gas is sold to neighbor industries for furnace heating. Hydrogen production would have no effect on furnace energy consumption but would reduce the climate gas emissions.

Reference

Ida T. Kero, Halvor Dalaker, Silje Fosse Håkonsen, Trine A. Larssen and Roger Khalil: Potential uses of CO-rich off-gas from Mn ferroalloy production. SINTEF Report 2018:00171. HighEFF Deliverables D6.1_2018.01 and D6.1_2021.01

HighEFF goals contribution:

- ÷ 10 %**
Greenhouse gas emissions
- ÷ 30 %**
Specific energy consumption
- Increased value creation

Contribution towards HighEFF goals: Ca 10% less CO₂-equivalents emitted



Oil & Gas heat pump concept

Innovation Type:
Concept



Development stage (TRL):

The HTHP technology is available at TRL 7-8

Contact: Ole Marius Moen
(ole.moen@sintef.no)

Concept for large scale HTHP integration on oil & gas installations

Challenge

More and more offshore/onshore petroleum installation are performing electrification to reduce emissions. These installations also have a significant heat demand from e.g. processing. However, as heat recovery from gas turbines to provide heating is no longer an alternative when installations are electrified, the heating demand needs to be covered by other means, e.g. inefficient direct electric heating. However, on these installations there are also significant cooling demands which are potential heat sources that could be upgraded and re-used as process heat through High-Temperature Heat Pump (HTHP) technology.

Solution

A concept was developed assessing the energetic potential for using large-scale HTHPs as an alternative to electric boilers for process heat delivery for an existing petroleum production platform operated by Equinor. Based on a screening of relevant working fluids and compressor technologies, the final HTHP concept was a two-stage cycle with intermediate intercooling based on butane (R600) working fluid and turbo compressors with a thermal capacity of 8 MW. The heat pump is directly integrated to the petroleum processing stream. A maximum Coefficient of Performance (COP) of 4.1 and satisfactory performance over the lifetime of the field was achieved, due to good thermal balance between the heat demand and heat source over time. This resulted in potential accumulated energy savings of 387 GWh (76%). Estimated emissions savings were also 76%.

Potential

There is a great potential for energy savings by using HTHPs to cover the thermal energy demand on in case of electrification of petroleum installations. The TRL of the technology is now at a stage where a pilot installation is feasible. However, practical considerations needs to be made, such as space and weight limitations, complexity and level of integration, potential re-design of heating and cooling systems and the heating and cooling load profiles over time.

Reference

- [Case study - one pager \(2024\)](#)

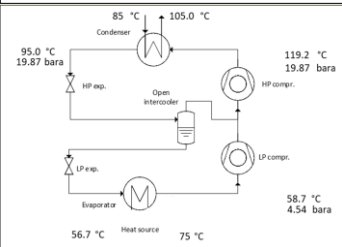
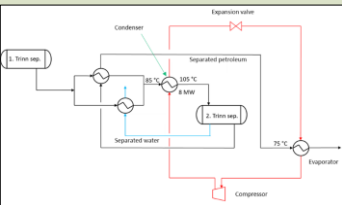

HighEFF goals contribution:



÷ 10 %

Greenhouse gas emissions



÷ 30 %

Specific energy consumption



Increased value creation

Contribution towards HighEFF goals:

In case of electrification of petroleum installations, the use of HTHP technology enables waste heat recovery and significant energy savings (70-80%). HTHPs may also bring additional value creation due to reduced load on the electrical grid.





Flexible offshore oil and gas platform model

Innovation Type:

Model

Methodologies



Development stage (TRL):

TRL: 3 - 4

Contact: Yessica Arellano

((Yessica.arellano@sintef.no)

Assessing different energy-efficient technologies on a variety of configuration relevant to offshore platforms requires a somewhat generic model. An entirely generic model is not practically feasible. However, a flexible and automated one would prove highly beneficial for various analyses and future use.

Challenge

Offshore oil and gas facilities are complex and often unique. Each facility is developed to the requirements of the producing field's reservoir and fluid conditions. Assessing the applicability of low-emission solutions, if no generic model is in place, requires extensive dedicated case studies. A flexible model, validated with real field data from a number of facilities, would ease evaluation and comparison of promising configuration alternatives based on key performance indicators of interest, e.g. carbon footprint, energy efficiency, costs, etc.

Solution

A comprehensive and flexible oil and gas platform model to contrast energy-efficiency solutions and their relative effect in reducing emissions.

Potential

The flexible offshore platform model developed in HighEFF was validated against real data for two platforms in operation. In each case, minimal deviations were illustrated. A 2021 HighEFF case study using the developed model showed that over a 30-year lifespan, a proposed configuration would reduce CO₂ emissions by 54 %. Extended applicability of the model developed for offshore platforms may facilitate important decision support for measures that can reduce the current high level of emissions in this sector.

Reference

Foulkes, J. 2021, Future Low Emission Oil and Gas Platforms. Master thesis

Foulkes et al., 2022. Future Low Emission Oil and Gas Platforms (paper under revision)

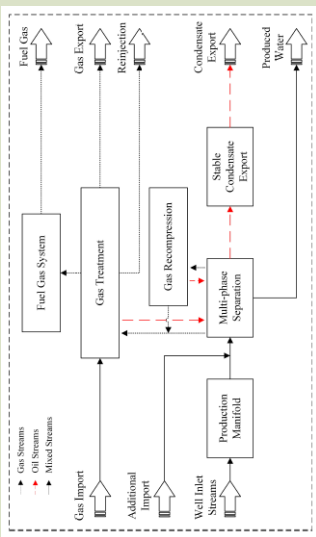

HighEFF goals contribution:



÷ 10 %

Greenhouse gas emissions



÷ 30 %

Specific energy consumption



Increased value creation

Contribution towards HighEFF goals:

The innovation contributes to HighEFF goals by presenting a versatile model that enable energy companies to retrofit (or reconfigure) platform energy utilities to minimize emissions and increase energy efficiency.



Combined heating and cooling with TES in food industry

Innovation Type:
Concept



Development stage (TRL):
8-9

Contact: Ole Marius Moen
(ole.moen@sintef.no)

Challenge

In various industrial processes, such as dairy production and brewing in the food industry, there is often a need for simultaneous cooling and heating. Typically, these demands are provided using two separate systems, one for cooling and one for heating. Often there are also high peaks in either the cold or heat demand which results in large installations operating at part load most of the time.

Solution

High-temperature heat pumps (HTHP) that use natural working fluids offer an energy-efficient and sustainable solution. A propane-butane cascade HTHP is able to supply cooling by exploiting the propane's properties and heat using butane. This type of HTHP is installed in a Norwegian dairy and can simultaneously supply ice-water for cooling at 0.5°C and process hot-water at 112°C. The measured combined heating and cooling COP is between 3.0 and 4.0, with an average of 3.4. Another possible solution is a hybrid HTHP using a mixture of ammonia and water as working fluid. The HTHPs can also replace gas boilers in other food industries such as fish processing plants.

TES has been proved to be useful in both food processing industry and retail sector to operate their systems at a more constant load, reducing installations and investment cost to cover their high and low peaks/demands.

Potential

Implementing HTHPs in the food industry may result in fossil free heating and cooling, as well as in a significant reduction of energy demand, by recovering and utilizing surplus heat. By additionally implementing TES, the potential for reducing installed capacities for HPs and other installations is even greater as it deals with the highest peak loads.

Reference

[D6.3 2022.02 REMA1000 - signed.pdf](#)

[D6.3 2021.04 Energy efficiency measures in fish meal processing.pdf \(sharepoint.com\)](#)

[2023 HighEFF Lunsje seminar SkaleUP HTHP Final.pptx \(sharepoint.com\)](#)

HighEFF goals contribution:



÷ 10 %

Greenhouse gas emissions



÷ 30 %

Specific energy consumption



Increased value creation

Contribution towards HighEFF goals:

The concept of combining heating and cooling in the food industry has a great potential of reducing both emissions and energy demand in the food industry. Integrating a TES reduces the peak power demand even more. This concept has a great potential of being transferred to other industries as well.



HTHP integration in the fish industry

Innovation Type:
New application



Development stage (TRL):
8

Contact: August Brækken
(august.brakken@sintef.no)

Challenge

The production process of fishmeal and fish oil has long traditions in the Nordic countries. The process is quite standardized and has not changed much for the last decades. The main energy consumers in fishmeal and -oil production are the cooker, evaporator, and dryer. The heating requirements of these processes are mainly provided by steam which is commonly produced with fossil fuels such as coal, natural gas, or oil.

Solution

Possible improvements for the system includes the use of direct heat exchangers and high temperature heat pumps (HTHP) to utilise waste heat and reduce the energy consumption of the processes. There is a large potential for heat recovery and energy savings in the fish meal plant. Direct heat exchange can be used to preheat the raw material before cooking, though there are challenges and uncertainties related to this. Waste heat from the dryer can be utilized by a HTHP to provide the dryer's own heating demand. This has a large potential for energy saving, especially for disc dryers and superheated steam dryers.

Potential

For a greenfield fish meal processing plant, there is a potential of reducing as much as 75 % compared to a typical layout by direct heat exchange and HTHPs. In this case, the fossil energy consumption is reduced with 94% when replacing a gas fired boiler with a HTHP. This corresponds to an 87% reduction in CO₂. For a brown field processing plants, it was viewed as most realistic to save between 12-39% dependent of how many processes are involved. These energy savings implies a CO₂-reduction of 18-41%.

Reference

- Deliverable D6.3_2019.03
- Deliverable D6.3_2021.04
- Deliverable D6.3_2022.03

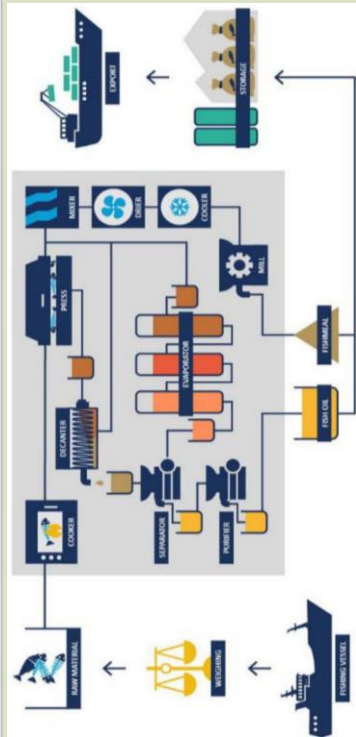

HighEFF goals contribution:



÷ 10 %

Greenhouse gas emissions



÷ 30 %

Specific energy consumption



Increased value creation

Contribution towards HighEFF goals:

The integration concept with a HTHP in a fish meal processing plant has the potential of reducing the total energy consumption by 12-75% depending on the plant outline and processes involved. If the technology replaces a gas fired boiler, the CO₂-emissions may be reduced with up to 87% for the highest energy saving potential.



Integrated HTHP and TES for combined heating and cooling in dairy sector

Innovation Type:
New application



Development stage (TRL):
8-9

Contact: Ole Marius Moen
Simple concept sketch
ole.moen@sintef.no

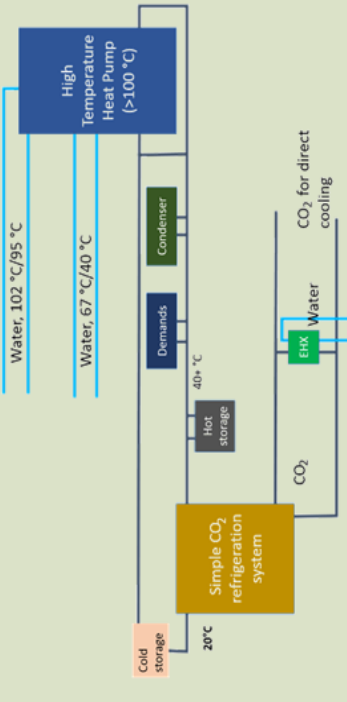

Challenge

A dairy has typically simultaneous heating and cooling demands, often supplied by at least two separate systems (cooling and heating). The dairy industry is currently heavily reliant on fossil fuels. At the same time, there are large amounts of low temperature surplus heat currently not utilized. Today, standard solutions include separate cooling and heating with electricity, gas boilers, and district heating.

Solution

One solution for making this industry fossil free may include direct and indirect cooling and heating and the use of a high temperature heat pump (HTHP). Both a propane/butane cascade HP and a hybrid HP (ammonia and water mix) has been installed in two Norwegian dairies and proved to be a good solution. Choosing the correct heat pump type may result in combined heating and cooling with one HP system. A thermal energy storage (TES) would take a natural part in the energy system in this case.

Potential

Integrating a HTHP to simultaneously provide both heating and cooling demands has the potential of turning the dairy industry to be fossil free and reduce the energy consumption by 38-55%. Waste heat from the dairy industry is in this way exploited and the system achieves a significant increase in energy efficiency. The potential of implementation is great and within reach, as market ready heat pump solutions for these applications are already available.

Reference

- Kvalsvik, K. H.; Bantle, M.: *Generating hot water for food processing plant using waste heat, high temperature heat pump and storage* (2018), Gustav Lorenzen Conference of Natural Refrigerants.
- Project "Sustainable and efficient heat pump development for combined process heat and cool – SkaleUp"

HighEFF goals contribution:

- ✓ **÷ 10 %**
Greenhouse gas emissions
- ✓ **÷ 30 %**
Specific energy consumption
- ✓
Increased value creation

Contribution towards HighEFF goals:
 Reduce carbon emissions by 53-95%.
 Save primary energy up to 55%.



Agricluster for low temperature surplus heat utilization

Innovation Type:
Concept



Development stage (TRL):
The integrated agricluster is at TRL 2, but most components are implemented at TRL 7-9

Contact: Magnus Windfeldt
(magnus.windfeldt@sintef.no)

Challenge

Low-temperature surplus heat from metallurgical processes represents a major energy source that is rarely fully utilized due to a lack of local demand in rural areas. Low-temperature heat may be utilized in the food industry, such as in greenhouse production or fish rearing, or in district heating. However, the individual demands of these heat users are typically small compared to the amount of available surplus heat, and are also subject to seasonal demand.

Solution

This work considers the combination of multiple low temperature heat users into an integrated cluster, in which byproducts from one process can be used as feedstock in another. The suggested agricluster is built around an aquaponic system combining greenhouse production and fish rearing for resource-efficient food production. Insect rearing is introduced to produce feed from the biomass waste. All these processes can benefit from using surplus heat primarily during winter, so seaweed drying is also included to increase the heat utilisation during summer.

Potential

The proposed agricluster allows for increased utilisation of low-temperature surplus heat by integrating multiple heat users, in a way that accounts for the seasonality of heat availability and demand. By exploiting synergies in material streams between the individual processes, it also facilitates more sustainable production of food, feed and biomass. Increased local production can also help reduce GHG emissions and environmental impacts of food and feed imports. The modularity of the concept allows for adaptation to local conditions, such as existing industry and heat availability.

Reference

Reyes-Lúa A., Straus J., Skjervold V.T., Durakovic G., Nordtvedt T.S. *A Novel Concept for Sustainable Food Production Utilizing Low Temperature Industrial Surplus Heat*. Sustainability, vol. 13, Multidisciplinary Digital Publishing Institute; 2021, p. 9786. <https://doi.org/10.3390/su13179786>.

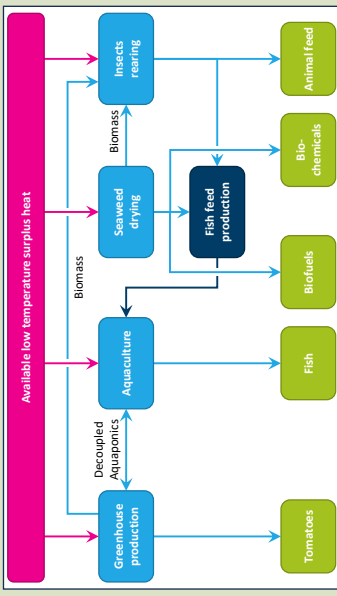

HighEFF goals contribution:



÷ 10 %

Greenhouse gas emissions



÷ 30 %

Specific energy consumption



Increased value creation

Contribution towards HighEFF goals:

Significant value creation can be achieved through the creation of new industries in an agricluster powered by surplus heat. Subsequently, the increased and more sustainable food and feed production can help reduce GHG emissions from import and land use.

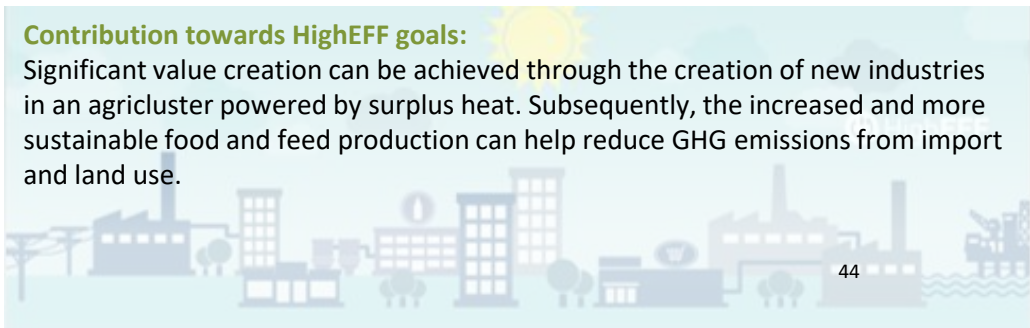



Cost evaluation of industrial heat recovery for external usage

Innovation Type:
Methodology
new application



Development stage (TRL):
 TRL 1-3

Contact: Magnus Windfeldt
magnus.windfeldt@sintef.no

Challenge

There is a large potential for using low temperature surplus heat from Norwegian industrial processes in rural areas to facilitate novel value creation in its local area. While several options for such external usage has been explored in HighEFF, there are large uncertainties related to costs in the implementation, especially when upscaled to meet the large amounts of available heat. Typical methods for techno-economic cost evaluation rely on large amounts of historic cost data, which is mostly unavailable for industrial heat recovery solutions. This is likely to be true for any novel heat using processes as well.

Solution

Cost curves developed for chemical processes, relating equipment size to purchase cost, are used to estimate the cost of heat recovery equipment over a wide range of scale. Combined with pilot-scale cost data of the novel industrial process upscaled with an estimated learning curve, a cost estimate of novel value chains using surplus heat as input can be achieved. Uncertainties related to lack of data and upscaling are included by providing selected technical input parameters as probability distributions and performing the cost analysis in a Monte Carlo fashion. Thus, the resulting cost estimates are probability distributions as well. In the referenced work, the method is developed and exemplified on a seaweed cultivation value chain using metallurgical surplus heat for drying.

Potential

The developed method has the potential to increase the implementation rate of industrial heat recovery and facilitate new business development around surplus heat sources by giving cost estimations of value chains under uncertainties related to cost data and upscaling.

Reference

Windfeldt M.K., Nordtvedt, T.S., Broch, O.J., Jordal, K., Knudsen, B.R.. *Large-scale seaweed drying using industrial surplus heat: A techno-economic assessment*. Unpublished manuscript draft.

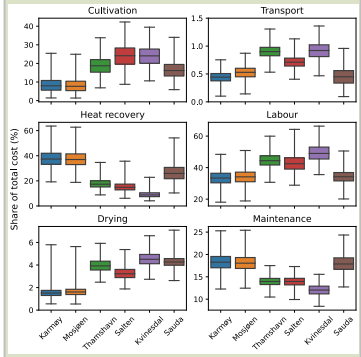

HighEFF goals contribution:

- ÷ 10 %**
Greenhouse gas emissions
- ÷ 30 %**
Specific energy consumption
- Increased value creation

Contribution towards HighEFF goals:

Cost evaluation of novel value chains can accelerate the development of new and sustainable industry, providing value creation from heat recovery. Facilitating local production of food and feed can also reduce GHG emissions from imported goods.



