



# 2020 ANNUAL REPORT

Centre for an Energy Efficient and  
Competitive Industry for the Future



HighEFF

# Table of contents

<b>3</b>	By numbers
<b>4</b>	HighEFF: Making Norwegian industry the world's greenest
<b>6</b>	HighEFF best of 2016-2020
<b>8</b>	The Added Value Created by Joining an FME
<b>10</b>	HighEFF: the Way Forward after reaching the midpoint
<b>14</b>	Our contribution to a more sustainable world
<b>16</b>	Keeping Ice Cream Cold Doesn't Have to Harm the Environment
<b>20</b>	Providing value to Industry in Just 8 Weeks
<b>21</b>	NEC INTERCUR: Integrated Energy Systems for Industrial Clusters
<b>22</b>	Numerical Fluid Mechanics: CFD Made Simple
<b>24</b>	How Hotels Can Slash Their Energy Bills
<b>28</b>	Reusing waste heat: a practical example
<b>32</b>	She completed her PhD with HighEFF – Now she's using the results in new projects
<b>35</b>	Vision and goals
<b>36</b>	How we work together
<b>37</b>	International cooperation
<b>38</b>	Organisation
<b>42</b>	Innovations
<b>45</b>	Research and Results
<b>60</b>	Research Infrastructure
<b>62</b>	Spin-off projects
<b>64</b>	Education, researcher training and recruitment
<b>67</b>	Communication
<b>70</b>	Appendix
<b>78</b>	Statement of accounts
<b>79</b>	Publications 2016-2020

# By numbers



**42** PARTNERS



**8** YEARS



**400** MNOK

## People

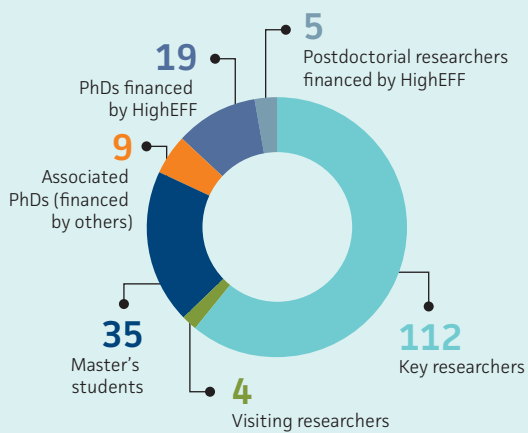

## Communication and dissemination

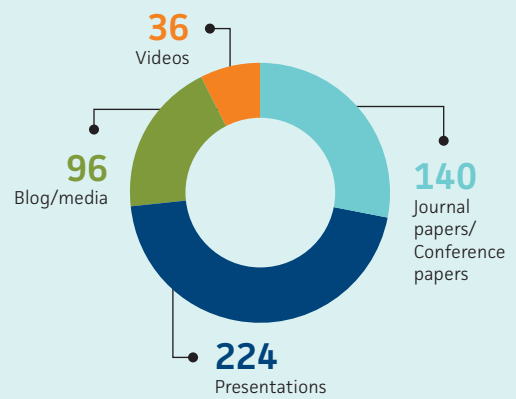

# HighEFF: Making Norwegian industry the world's greenest

HighEFF has defined ambitious goals for development and demonstration of technologies that may improve energy efficiency and reduce emissions from industry. Energy efficiency measures are to be considered as necessary and enabling for a transition to a low emission society, as presented by the IEA projections to meet the 2-degree target put forward in the Paris agreement. A kWh not used does not have to be produced. Measures to reduce the energy consumption and emissions from the industry are often less costly than alternative measures. Energy efficiency measures will thus be very important for an optimal transition from a social economic and environmental perspective, and in order to maintain

and increase value creation in society.

**A kWh not used does not have to be produced.**

Improved industrial energy efficiency can be achieved by improving the core industrial

processes, as well as by capturing and harnessing waste heat and other surplus energy streams, either within the individual industry, or in nearby buildings or industries. In cases where the heat cannot be utilised directly, this may be done by upgrading the heat to a higher temperature level by use of heat pumps or by converting the heat to power. These are tasks that are addressed in FME HighEFF - Centre for an Energy Efficient and Competitive Industry for the Future.

Large amounts of surplus energy are wasted in industry, mainly in the form of heat. Inefficient processes result in losses in the form of heat or other surplus energy streams. The amount of annually produced waste heat is as high as the total heating demand in Europe! The heat may however not be available at a high enough temperature level for uti-

lisation, and often there are no potential users near the plant. In this context, conversion, energy storage and development of industry clusters are important elements to obtain optimal utilisation of the energy.

Apart from a goal of improving energy efficiency by 20-30%, HighEFF aims to reduce climate gas emissions from industry by 10%. This includes reducing both indirect emissions due to energy consumption as well as direct emissions from industrial processes, refrigeration, heating and drying processes. Heat pumping processes utilise to a large extent synthetic refrigerants that are strong climate gases. The research groups involved in HighEFF have for a long period been developing similar processes based on natural refrigerants, that are not harmful to the environment, and this work will be continued within the Centre.

Improving industrial energy efficiency is a joint effort. HighEFF is a collaboration project between many national and international universities, research institutes and industry partners. In total, there are more than 40 partners from three continents. The industry partners represent all the largest industry sectors in Norway: Metal producing industries, oil, gas and energy companies, chemical industry and the food industry. HighEFF is led by SINTEF and NTNU.

During the first years of operation, 24 out of 25 PhDs and PostDoc fellows have been engaged and the centre has progressed well in establishing real case studies for the industry partners. These are cases where knowledge, technology and solutions developed within FME HighEFF can be applied in real industrial applications to increase efficiency and reduce emissions. Some of these cases have already





*In Orkanger, Orklandbadet (with solar cells on the roof) receives waste heat from Elkem Thamshavn (in the background).*

been taken further as spin-off projects in the industry, with co-funding from ENOVA, for instance.

A case study on the potential for implementation of energy efficiency measures for a new TINE dairy has already been realised. Measurements from the plants show a reduction in energy consumption of 38% and a reduction in greenhouse gas emissions of 42% compared to existing dairies, by implementation

of high temperature heat pumps and by a good system integration. The estimated potential from the HighEFF case study was respectively 40% and 47%, consequently a very good goal achievement, considering that not all proposed measures were implemented – because of economic reasons. More information about this and other results can be found on the centre's web pages [www.higheff.no](http://www.higheff.no).

# HighEFF best of 2016-2020



Selected highlights – find more videos and stories on [www.higheff.no](http://www.higheff.no) -> Annual report

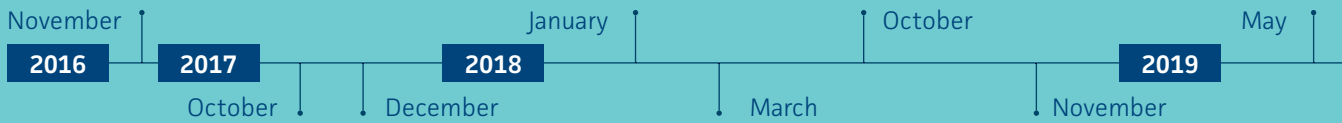



# -10 %

Greenhouse gas emissions

# -30 %

Specific energy consumption



Increased value creation



October



February



May



July

2020

June

May

May

August



June



May



May



August



Follow our account  
@HighEFF\_FME

# The Added Value Created by Joining an FME

Joining an FME represents an investment in both time, energy and resources for the industry partners. But what do they get in return? We asked some of HighEFF's partners to tell us about their experience.

## Sustainability

Sustainability was an important key word for Øystein Fjørtoft (REMA 1000) when talking about the benefits of joining HighEFF. "I'm personally very interested in doing things in a sustainable way. Not only sustainable from an environmental perspective, but also from an economic and societal perspective". REMA 1000 will soon have switched from traditional refrigerants to CO<sub>2</sub> for all its refrigeration in the whole country. "This enables us to save money, which in turn allows us to maintain competitive prices for our customers. It's environmentally sustainable, but also economically sustainable."

For TINE, the motivation to join was largely similar. With help from HighEFF, the dairy product cooperative built in Bergen a more energy efficient dairy, which is well on its way to achieve its target of 40% reduction in energy use compared to a traditional dairy. "We also have high hopes for high temperature heat pumps, says Kim Andre Lovas (TINE). We need high heat for pasteurisation and cleaning, among other things, and getting this from heat pumps would greatly contribute to reducing our energy use."

## Cross-pollination

Live Spurkland (Pelagia AS) points out the value of HighEFF as an arena for cross-pollination. "There's an exciting blend of suppliers and large industry taking part in the research centre, and the

meetings organised through HighEFF allow us to share experiences and ideas, which in itself is very valuable." The fish processing company joined HighEFF recently and has yet to implement any changes on its production line, but the hopes are high, particularly when it comes to energy-intensive fishmeal and fish oil production.

"HighEFF gathers a very interesting constellation of participants, says Arne Ulrik Bindingsbø (Equinor). There are sometimes solutions we don't know about that have already been implemented by other industries, and the centre gives us the chance to meet these people." He also points out the value of securing, through HighEFF, PhD/masters candidates with the right profile.

**We've actually connected with new customers through HighEFF's meeting arenas.**

Jan Haraldsen (Epcon) is another participant who points out the networking benefits of joining the centre.

The company provides evaporating technology for factories. "We've actually connected with new customers through HighEFF's meeting arenas. We're talking about industry who weren't aware of us, and whom we weren't aware of ourselves, but who needed our products." Looking forward, Jan Haraldsen has high hopes for high temperature heat pumps. "The solutions we offer our customers are designed to help with energy efficiency, through mechanical recompression of vapor, for example. With such a system we can lift the temperatures by 35 to 40 degrees. If we could make the process even more efficient, lifting temperatures by 50 to 60 degrees, the solution would become interesting for an even greater number of industries."





Photo: Rema 1000

*REMA 1000 will soon have switched from traditional refrigerants to CO<sub>2</sub> for all its refrigeration in the whole country.*

## Access to Top Notch Scientists

One of the main benefits for Terje Lillebjerka (Mo Industripark AS) has been the possibility to work for results which would have been out of reach without the support of the centre. "We have a relatively modest budget for R&D and wouldn't have had access to scientists had it not been for the fact that we became partners." HighEFF scientists are currently helping Mo Industripark with using its cooling water more effectively, as well as figuring out a way to store excess heat for later use.

Ellen Myrvold (Alcoa) points out that just having fresh eyes look at their processes can have an enormous value. "We had some raw materials that were unusable

and had to be discarded because they had a high water content. HighEFF scientists came to visit our facility and asked why we didn't just use our excess heat to dry those materials. It's a bit embarrassing to admit, but we just hadn't thought of it. Sometimes having fresh eyes come over and ask the right questions

**Sometimes having fresh eyes come over and ask the right questions can lead to eureka moments.**

can lead to eureka moments." Ellen Myrvold adds that collaboration with students has also helped put a new perspective on things. "Another benefit of getting students to work with us is that it allows us to show ourselves as an attractive workplace."

# HighEFF: the Way Forward after reaching the midpoint

The first four years of the HighEFF centre have been fruitful indeed. On many metrics (the number of spin-off projects or the number of innovations, for instance) the goals set initially have been reached already – and the work is continuing. On other metrics (number of PhDs and associated PhDs, for instance) the goal is nearly reached.

The emission and energy reduction objectives were widely exceeded for the Food and Chemicals sectors. The reductions have been even greater for the other

two sectors (Metals and Materials; Oil, Gas and Energy), when measured in absolute numbers. In percentage, however, they have yet to meet the target of 30% reduction in specific energy use and 10% reduction

**The potential to achieve concrete results in emission and energy reductions is even greater for the second half of the centre's operation.**



Photo: SINTEF

*HighEFFLab started operations this year.*



in CO<sub>2</sub> equivalent emissions. Expect more concrete result in these sectors during the next four years, says centre director Petter Røkke: "The potential to achieve concrete results in emission and energy reductions is even greater for the second half of the centre's operation. We've established a foundation during the first half that we will build on during the next." Peter Røkke points out that the research at early stages is naturally at a low Technology readiness level (TRL scale) but that as time progresses the various innovations get to a stage where they can be put to use by centre partners. This is expected to happen with a number of research projects in the next four years.

Helping research progress on the TRL scale will be the focus of HighEFFLab, which started operations this year. "This is a national infrastructure, says Chairman of the Board Arne Ulrik Bindingsbø. It will remain long after the centre has ceased its operations. Some of the installations are still under construction but activities have started and we are excited about what this means for getting our research to reach maturity."

## Securing benefits now and far into the future

Making sure that HighEFF's results continue to have an impact after the centre terminates in 2024 will be another priority for the next four years. "We're building a toolbox for energy efficiency, says Arne Ulrik Bindingsbø. Sometimes it doesn't make economic sense for industry to adopt the latest technology

immediately, because their current equipment is still far from reaching its life expectancy. Think of it as replacing your fossil-fuel burning car with an electric one. You're not likely to do it if you got a new car just a year ago." The idea with HighEFF's toolbox, he adds, is that the solutions will be there when the industry decides it's time to apply them.

### We're building a toolbox for energy efficiency

Another way in which HighEFF's research will exceed its lifespan will be through the continuation of its networking

activities, that have been lauded by so many of the centre's partners. "This cross-pollination – people from different industries and sectors exchanging ideas and solutions – has proven to be a popular and effective way for partners to achieve results. It will continue long after HighEFF closes its doors", says Petter Røkke.

## Educating the experts we need

For many large industries, implementing new solutions and technologies requires having in-house experts that can ensure everything goes smoothly. "Educating experts that can be employed by the industry is another way to make sure the new solutions we're developing will be used", says Arne Ulrik Bindingsbø. He adds that the PhD and Master's students working within HighEFF will be a precious resource to facilitate change from the inside, once they get employed by the industry.



## Chairman of the Board/Centre Director

**Arne Ulrik Bindingsbø** is Chairman of the HighEFF Board. His current position is Leading Researcher, Energy efficiency and CO<sub>2</sub> reducing technologies, Research & Technology, in Equinor. Arne Ulrik Bindingsbø earned a PhD in Materials Science from NTH in 1992. He has more than 25 years of R&D experience from the Oil & Gas sector. His focus area is to develop and execute R&D projects within the field of Operations & Maintenance. As the field of O&M consists of many technical disciplines, Bindingsbø is very focused on collaborative innovation to obtain R&D projects that result in industrial implementation. Since 2014, he has held a position as Adjunct Professor at the Department of Marine Technology, NTNU.

**Petter E. Røkke** is the Centre Director of HighEFF. His current position is Research Director for the Thermal Energy department at SINTEF Energy Research. Petter earned a PhD in Mechanical Engineering from NTNU in 2006. During his career at SINTEF, he has been active within the fields of CCS (CO<sub>2</sub> capture and storage), Bioenergy, and Industrial Energy Efficiency. Since 2011, he has been within the management group of SINTEF Energy Research, first as Research director for the Electric Power Technology department and since November 2012 for the Thermal energy department. He was chairman of the board for FME CenBio and is currently member of the board for FME Bio4Fuels.

*Arne Ulrik Bindingsbø (left) and Petter E. Røkke (right). >>*





# Our contribution to a more sustainable world

By increasing energy efficiency, value creation and competitiveness, while decreasing greenhouse gas emissions in a broad span of industrial processes across sectors, HighEFF contributes towards all 17 **UN sustainable development goals** (SDGs). But we have chosen to focus on four SDGs we consider as the most relevant and where we hope to achieve significant impact through our research.



Reaching climate goals requires access to clean, affordable energy. Two of the sub-goals for SDG 7 are to increase international collaboration on research related to clean energy and to double the world's energy efficiency by 2030.

Through HighEFF being a Research Centre for Environmentally Friendly Energy, having an international consortium and by reaching the greenhouse gas emissions reduction and energy efficiency goals, HighEFF will have a significant impact on SDG 7.



The SDGs are all dependent on cutting edge industrial innovation, one of the prime objectives of HighEFF. Together with industrial partners from a wide range of sectors, our research breeds

new knowledge and innovation on components and processes to make industrial processes more energy efficient.

Not only is this important for mitigating climate change and more responsible use of resources, it also brings down costs which in turn increases

competitiveness. This makes it very attractive to adapt HighEFF innovations from a business standpoint as well as a sustainability standpoint.



We must use the world's limited resources more responsibly and efficiently, in regard to both production and consumption. Enabling a 20-30% reduction in specific energy use in industrial processes means industrial actors will be able to produce the same amount with 20-30% less energy.

**In a world where poverty is declining and consumption levels are rising, energy- and resource-efficient production will be key.**



The climate is changing at dramatic speeds and we need to mitigate and adapt quickly. As a Research Centre for Environment Friendly Energy (FME), the most important job of HighEFF's research is to contribute to reaching SDG number 13.

Many of the products and processes we as a species are most dependent on are extremely energy intensive and/or produce large amounts of GHG emissions. Through HighEFF research we aim to enable at least a 10% reduction in GHG emissions from industrial processes by 2024 and enable a 20-30% reduction in specific energy use. This will have a significant impact on mitigating climate change effects from industries across the world.





# Keeping Ice Cream Cold Doesn't Have to Harm the Environment

Norway produces more than 60 million litres of ice cream every year, filling freezers across the country to the delight of... well... everyone, really. But many of the refrigerants used within air freezers, refrigerators and air conditioning systems can be extremely harmful to the environment. Older appliances especially contain hazardous components and gases that have a direct negative impact on the ozone layer and the greenhouse effect.











So is it possible to enjoy a frozen treat with a clear green conscience? If you're in Norway, the answer is yes. The reason? CO<sub>2</sub>. While carbon dioxide is often portrayed as a villain in the climate change debate, the flexible substance – along with other natural working fluids – could actually be the most important climate change mitigation tool we have.

## Why a change was needed

Earlier refrigeration units use chlorofluorocarbons (CFCs) or hydrochlorofluorocarbons (HCFCs), both of which are ozone-depleting substances and potent greenhouse gases. The Montreal protocol banned these. But the story didn't end there, because their most common replacement – hydrofluorocarbons (HFCs) – were later discovered to also be damaging to the environment.

It's not enough to simply take care when disposing of such equipment. The heat-trapping gases can be emitted during manufacturing, or leak during use or disposal. Now, the Kigali Amendment to the Montreal Protocol will ensure HFC use is phased down.

## Norway's supermarkets going green

In Norway, industry is already ahead of the game. Thousands of Norwegian supermarkets up and down the country have already switched to CO<sub>2</sub>-based chillers. If the rest of the world follows suit, the effect could be substantial. A global switch to ozone- and climate-friendly alternatives will avoid an increase of **half-a-degree** in global temperature by the end of the century.

There's another reason that a switch to CO<sub>2</sub> is green. The coolant can also be used in a supermarket's HVAC system, increasing energy efficiency and reducing a store's overall energy use. Simply put, it's a more integrated system that also means excess heat can be stored and utilised during the winter.

## Beyond Norwegian supermarkets

EU F-GAS legislation means that all of Europe will have to make changes in the years to come. While synthetic alternatives are being developed, CO<sub>2</sub>-based systems are proven and known to not damage the environment. Yet there is still work to be done.

CO<sub>2</sub>-based systems work well in cooler climates, but research is ongoing to increase efficiency in warmer climates such as southern Europe. The HighEFF research centre is looking at how to apply the technology into other industries. A spin-off project focuses on the application of the successful refrigeration solution in the hot climate of India, home to more than one billion people.

This change in Norwegian supermarkets has happened very much behind the scenes in recent years. You are unlikely to have noticed any difference, yet that very same ice-cream is now greener.





# Providing value to Industry in Just 8 Weeks



During the summer of 2020, SINTEF Energy Research hosted 30 summer interns. Despite coronavirus restrictions, the group was able to make a valuable contribution to SINTEF and our customers. One of them, Cosmin Aron, spent his eight weeks as a summer intern developing a tool to visualise the energy and material flows at the Mo Industry Park (MIP) in northern Norway.

Cosmin is working on a MSc in Global Manufacturing Management but decided to challenge himself by taking a sideways step into the world of energy efficiency. “This project really appealed to me. The process of mapping to visualise a process is applicable to any engineering or manufacturing scenario. It’s

the first step in any industrial improvement project to identify specific aspects with potential for improvement.”

Cosmin used a combination of tools including Excel and Visio to develop the solution. The results were well received by those at MIP and Cosmin’s team of researchers. Hanne Kauko, from SINTEF Energy Research: “I have high hopes that the tool will be developed further and used in the future, especially given the positive feedback from MIP.”

Find out more on the #SINTEFblog:  
<https://blog.sintef.com/sintefenergy/providing-value-to-industry-in-just-8-weeks>



Photos: Mo Industripark AS

Mo Industry Park (MIP) in northern Norway".





# NEC INTERCUR: Integrated Energy Systems for Industrial Clusters

The new industry-research collaborative project NEC (Novel Emerging Concepts) INTERCUR aims to develop a strategic decision-making tool for industrial clusters. Operational data provides a much-needed insight into existing infrastructure and potential bottlenecks in the system. By implementing this information in a mathematical optimization model, we wish to identify different industries that would interact synergistically with the current system.

At the same time, such a model could be used to optimize the current resource allocation within the cluster to detect potential savings.

Find out more on the #SINTEFblog:  
<https://blog.sintef.com/sintefenergy/energy-systems/nec-intercur-integrated-energy-systems-for-industrial-clusters>

# Numerical Fluid Mechanics: CFD Made Simple

Fluid mechanics is a branch of physics that describes the movements and behaviours of liquids and gases (fluids) – and computational fluid dynamics (CFD) is a way to solve the complicated equations involved using computers. The area where the flow is going to be investigated has to be described to the simulation by constructing a mesh: a visual representation of the area, subdivided into small squares. This is an important step, as a better mesh will reduce the calculation time, make the simulations more stable and cause fewer

errors. CFD is a versatile tool that can be used to solve a broad range of problems, such as designing new or improved components, creating improved models for system scale tools and creating digital twins of real products.

Find out more on the #SINTEFblog:

<https://blog.sintef.com/sintefenergy/numerical-fluid-mechanics-cfd-made-simple>

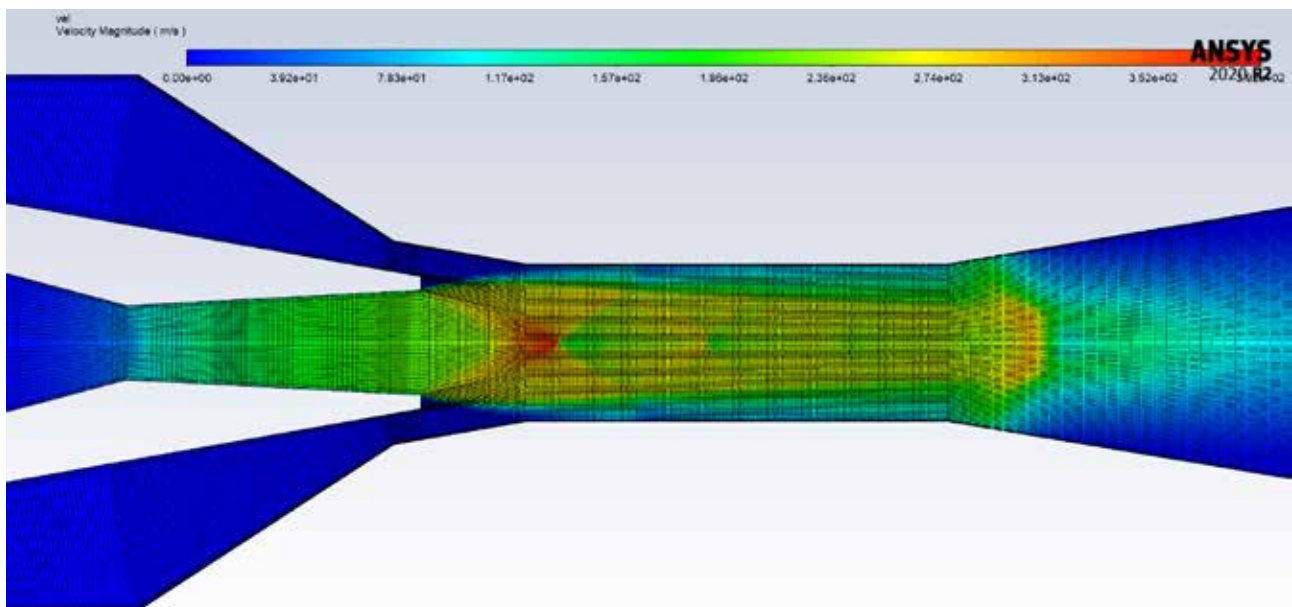

Photo: Knut Emil Ringstad

*A better mesh will reduce the calculation time, make the simulations more stable and cause fewer errors.*







# How Hotels Can Slash Their Energy Bills

The hospitality industry was hard hit by the Covid-19 pandemic in 2020, with revenue from guests and conferences dwindling to almost nothing. In that context, seeking out cost savings suddenly becomes more important than ever. An investment in the latest energy-efficient technology that combines heating and cooling into one system can reduce a hotel's total electricity usage by 44%.







## A time of economic challenge for hotels

The large scale vaccination currently starting in many areas is a reason to be hopeful, but it could still take a long time for revenue to return to pre-corona levels. At the same time, we are still in the midst of a climate crisis. If we are to meet the challenging goals of the Paris Agreement, drastic change is needed in every part of society. For a hotel, that change could be good for business as well as the environment. A survey of 72,000 guests by one leading global hotel chain revealed 33% of people prefer hotels with environmental and social programs. The proportion jumped to 44% for younger guests.

New research associated to the HighEFF research centre shows that hotels can play their part in tackling the climate crisis and take a substantial bite out of their operating costs by switching to a CO<sub>2</sub>-based HVAC system. Given the two major challenges we face today, that's a win-win.

## One system for the complex requirements of hotels

Hotels are about so much more than just the guest rooms. They are buildings with complex systems for hot water, heating, and cooling. Different parts of the hotel will have drastically different requirements at different times. Because of this, the industry standard has been to use separate systems each dedicated to a specific function. However, even if each individual component is energy-efficient, a vast amount of energy is wasted when seen from a total system perspective.

Combining all a hotel's thermal systems into one single system that can provide heating and cooling gives far

greater efficiency. That means lower energy usage, lower costs, and less impact on the environment. The first "all-in-one" CO<sub>2</sub> heat pump was installed in a Norwegian hotel in 2018. A 63% reduction in the use of electricity for heating and cooling was achieved in its first two years of operation. For an average hotel, this represents a 44% reduction in total electricity usage.

## How combined heating and cooling works

Silje Marie Smitt spent the last few years on her NTNU-funded PhD – associated with the HighEFF research centre – working on "all-in-one" CO<sub>2</sub> heat pump systems for hotels". She explains that the efficiency gains come from taking advantage of simple heat transfer concepts: "When cooling is required, the heat that would otherwise be wasted is removed, stored and used when and where the heat is required. That means heat can be recovered from ventilation cooling and be used for room heating and hot water production."

Within the system, working fluids perform the task of upgrading the thermal energy from cold to hot and transfers it from one place to another. Previously CFCs and HFCs were among the substances used for the job, but they have since been prohibited due to their environmental impact.

"CO<sub>2</sub> is an ideal natural working fluid for heat pump systems and commercial refrigeration. It covers a wide temperature span within the same cycle, typically from -30° to 90°C," says Petter Nekså from SINTEF Energy Research. Although CO<sub>2</sub> is often cast as the villain in the climate change debate, its use as a natural working fluid is a positive one. "Contrary to many other heat pump chemicals, CO<sub>2</sub> as a natural working fluid





*Hotels are buildings with complex systems for hot water, heating, and cooling.*

is often a recovered by-product from other industrial processes,” Nekså adds.

## Heat storage reduces peak demand

Another benefit of heat storage is the ability to shift energy demand and reduce peak loads. Providing hot water accounts for 40-70% of a typical hotel's total energy usage, but a lot of that demand is concentrated in two peaks during the early morning and late evening. Heat storage provides a buffer to cover excess demand during these times, helping the hotel to avoid peak energy tariffs. In addition, there are operational

savings to the hotel's thermal systems and an increase in operational stability.

## How much can hotels save?

The Scandic Hell hotel in central Norway achieved a 63% reduction in the use of electricity for heating and cooling in its first two years of using an “all-in-one” CO<sub>2</sub> heat pump. The expected payback time depends on a hotel's consumption level. As the technology is not yet available “off the shelf,” payback is currently between 3 and 7 years. Ongoing HighEFF research aims to bring that time down by increasing the availability of the technology.



# Reusing waste heat: a practical example

Martin Grimstad, a 26 year old process engineer, got to experiment with waste heat reuse in a very hands-on way at the Alcoa aluminium smelter in Mosjøen. His HighEFF-related master's thesis was about "pre-warming anodes in aluminium production" and demonstrated how heat that would otherwise go to waste can be used to save electricity – and money.

Photo: courtesy of Alcoa Corporation









## Aluminium production explained

To understand exactly what Martin tested, we first need to take a look at how aluminium is produced. First you take a large steel vat called a reduction pot. In the bottom of that pot are carbon cathode. Next you have an electrolyte solution, the input material (aluminum oxide) and finally, at the very top, some anodes, also made of carbon. These weigh one tonne each when they are new.

An electric current gets passed through the anode, the electrolyte solution and the cathode, and a chemical process happens that results in liquid aluminium (which sinks to the bottom) and CO<sub>2</sub> gas.

The fact that CO<sub>2</sub> is emitted means that the carbon gets slowly used up, so the anodes have to be replaced about once every month. Because there are 18 anodes in the vat, and because it would be logistically impractical to switch them all at once (and also cause great disturbance to the cell), every two to three days, two anodes are replaced.

These old, used up anodes will be recycled to make new ones, but first they must cool down. This is where Martin Grimstad comes in.

### Reusing heat

"The chemical process that makes aluminium only works well at temperatures around 960°C, says Martin Grimstad. When you place two new, room-temperature anodes in the vat, you cool down its contents significantly, particularly in the area that's immediately adjacent to the new anodes." It takes about one to two days for the temperatures to go back to normal after new anodes are put in.

The idea, then, was to simply use the old anodes to warm up the new ones.

This was done by simply placing two hot, old anodes on either side of one cold, new one. Let them sit there for a while and then measure the effect. Measurements were taken after 1 hour, 2 hours and 4 hours. A hole was drilled in the new anode to measure its core temperature. Results were encouraging. After four hours between two old anodes, a new anode's core temperature was 150°C, while its surface temperature was 250°C. This is energy that won't have to come from the vat anymore, which means less use of electricity, and ultimately a cheaper production process.

All this from heat that would have been wasted anyway.

### Presenting results

Martin Grimstad got to present his results at the HighEFF Annual Consortium Meeting. "It was a bit nerve-wracking to present in front of all these smart people, but ultimately a nice experience. The results were well received by the audience."

### A solution full of potential

The technique used for heat reuse in this case was quite simple, according to Martin Grimstad, and could be improved upon even further. "We could have the hot anodes in some kind of closeable enclosure to minimise loss from radiating heat."

More work also needs to be done before such a solution gets put to use. "Switching those anodes is precise work that requires careful planning. With 400 vats at the smelting plant, it's a lot of anodes to



switch and if they have to sit there for 4 hours to warm up, it will change the whole schedule. In the future, this could be solved with other improvements like robot cranes, for example."

**Martin Grimstad completed his HighEFF-related master's degree and currently holds a position as a process engineer at Alcoa Mosjøen.**



# She completed her PhD with HighEFF – Now she's using the results in new projects



Trine Larssen was one of the first HighEFF research fellows to defend a PhD on December 17<sup>th</sup>, 2020, with her topic related to more environmental metal production. She now works as a researcher at SINTEF, where industry

partners are benefitting from her HighEFF knowledge in other projects.

## The large potential for emissions reductions in the metal industry

Norwegian industry is responsible for a quarter of the country's greenhouse gas emissions. This is 43% less than just 30 years ago, but there is still room for larger cuts.

– The metal industry alone accounts for over 10% of Norwegian emissions. Obviously, if we are to reach our climate targets, we need to do research on how the metal industry can do its part, says Larssen.

Trine Larssen now works at SINTEF, where she researches metal production on behalf of the industry. In her doctorate, she specifically examined how ferromanganese production can become more energy efficient.

– Ferromanganese is an unknown metal for many, but we produce a lot of it in Norway. It is used as an alloying element in steel, so it's a very important metal despite it being relatively hidden from view for most people.

Greenhouse gas emissions by industry in 2019  
CO<sub>2</sub>-equivalent – millions of tonnes

Norway's total greenhouse gas emissions

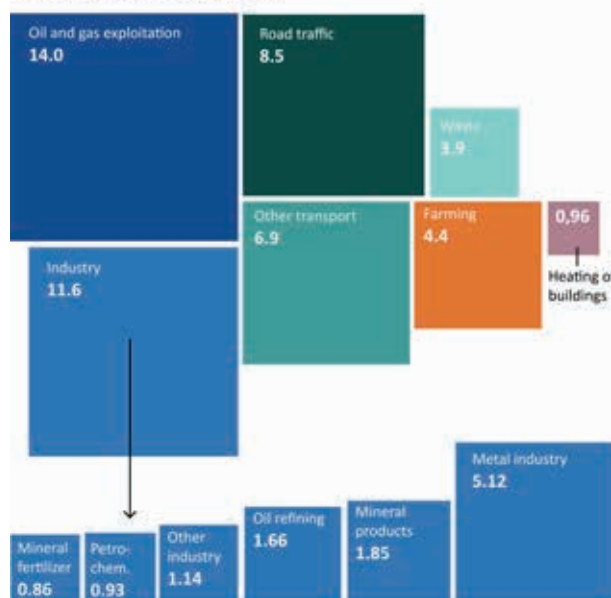

Source: Norwegian Environment Agency and Statistics Norway 2020 / Miljøstatus.no

## Using PhD results in projects that are relevant for the industry

Many of the companies producing ferromanganese in Norway are HighEFF partners. They were closely involved in Trine Larssen's research to help make sure the PhD was as relevant as possible to the industry. Specific issues and questions from ferromanganese producers were central to Larssen's work. The industry was involved in her research throughout, which has proved very valuable to both parties.

– The industry confirmed that the skills and knowledge I have acquired are both useful and usable to them. The doctorate also placed me in an advantageous position to get the job I have today.



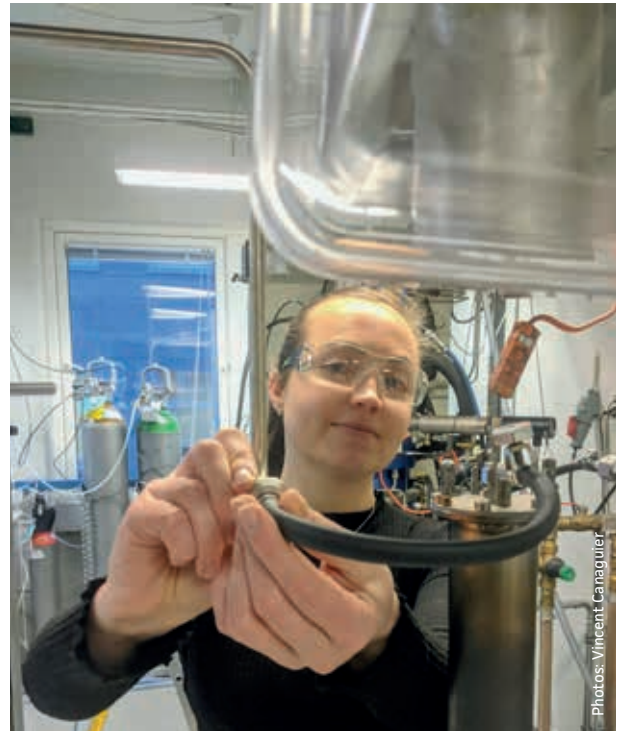

*Trine Larssen now works at SINTEF and is building on the results presented in her PhD as part of her work.*

– The companies I worked with as part of HighEFF are taking part in many other SINTEF projects. During the two months I have worked here, I have had the opportunity to work for metal industry-related projects where I'm basically building on the results presented in my PhD.

## A more energy-efficient industry

– Making processes more energy efficient is a crucial part of greening up any type of industry. Broadly speaking, improved energy efficiency means that a factory produces just as much as before, but with less

energy. In other words, they get more, for less, Larssen explains.

When Larssen was tasked with examining how ferromanganese production can become more energy efficient, she had to look at the amount of energy required to produce the metal, as well as the types of exhaust gases released during production.

– During production, carbon is used to remove oxygen from the ore. This means that we also generate lots of carbon monoxide (CO) and carbon dioxide (CO<sub>2</sub>) that get released from the furnace as exhaust gas. This gas

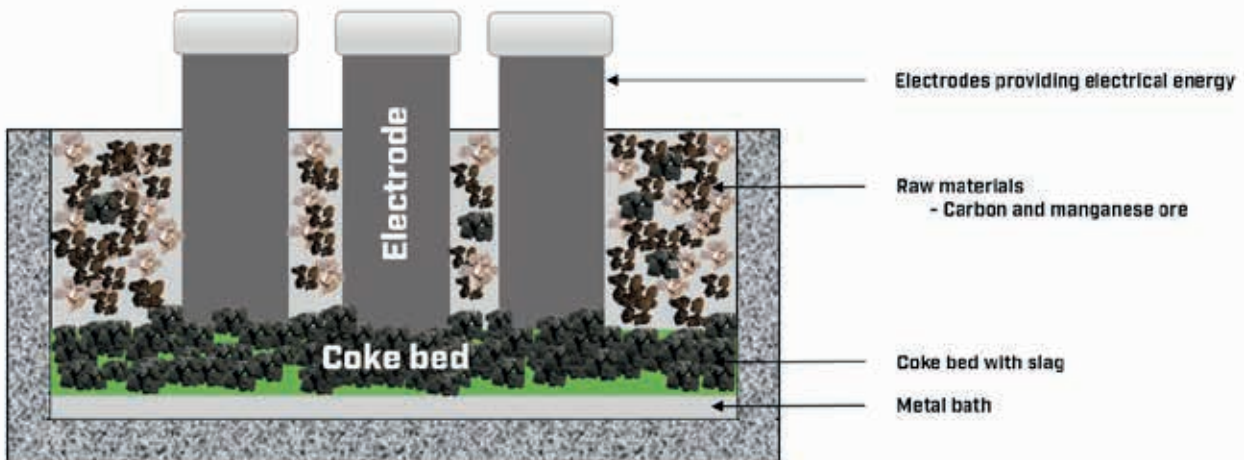

can almost be seen as a side effect of the process. It's unavoidable if we're going to be producing the metal, Larssen explains.

She adds that of all the chemical reactions happening during ferromanganese production, a few are particularly interesting to look at more closely.

– Some reactions that happen between the ore and the gases in the furnace have a great effect on energy use and greenhouse gas emissions. In my doctoral thesis, I delve into these reactions for two different types of manganese ore – comparing their effect on energy use and exhaust gas generation.

These results were used to calculate the size of CO<sub>2</sub>-equivalent emissions generated by the industry when they use these different types of ore. Larssen also established how the size of the ore affects emissions. Finally, she found out what kind of effect the composition of the gases present in the furnace has on the chemical reactions happening inside.

## How was it to do complete a PhD in collaboration with HighEFF?

– HighEFF is different from other research centres I worked closely with in the past, because it collaborates with such a wide variety of industries. This means that I've simultaneously scrutinised a topic in great detail and widened my horizons.

Larssen says she also learned how to work more efficiently during the course of her doctorate work.

– Taking a deep dive into a single topic for three years is not something you get to do very often. It's a very special thing, and you have the time to really leave no stone unturned. Yet this process has taught me to balance my time use against the goals of my work. When you do a PhD, you have a lot of time, and that means I can sometimes get side-tracked by details that are perhaps not that important in the grand scheme of things. Knowing how to get to the point you have reached to find out what is important – but no further – that is a skill I will remember.

# Vision and goals

## Vision

**Joint effort for creating a competitive, energy efficient and environmentally friendly industry for the future**

Energy preservation and security is a global challenge. There is a global shortage of energy supply, and the way we use and produce energy today is causing greenhouse gas emissions contributing to climate change.

Norway and the EU have ambitious targets towards energy and climate. At the same time, there will be an increased demand for energy in the years to come. There is a clear need for reduction in industrial emissions and more effective industrial energy systems. If one industrial plant can be more energy efficient, there will be more available energy for other purposes. Also, Norway depends on being more energy efficient to maintain a competitive industry in the future, both nationally and internationally. As part of solving this problem, FME HighEFF was established in 2016.

## Goal

HighEFF will spearhead the development and commissioning of emerging, energy efficient and cross-sectorial technologies for the industry, and:

- Enable reductions of 20-30% in specific energy use and 10% in emissions through implementation of the developed technologies and solutions for the HighEFF industry partners, thereby supporting the ambitious targets set by the EU and national authorities.
- Allow value creation for Norwegian industry by developing 15 to 20 new innovative solutions for energy and cost-efficient plants, energy recovery and use of surplus heat.
- Develop methods and tools for analysis, design and optimisation of energy efficient systems.
- Build an internationally leading Centre for strategic research within industrial energy efficiency.
- Generate 6 KPN, 8 IPN, 6 DEMOS and 4 EU spin-off projects.
- Enable competence building by educating 22 PhD/Postdoc candidates, 50 MSc candidates, and training/recruiting 30 experts in industrial energy efficiency.
- Disseminate and communicate project results; 150 journal articles and conference papers.







# International cooperation

International cooperation is emphasised in the centre activity. Among the partners in the centre, there are several international universities and research institutions. This also holds for the vendor and end-user partners, as well as many of the Norwegian companies with considerable international activities. This ensures the necessary interaction and input required to focus activities on the challenges faced by industry and the energy system in the transition to a society with considerably lower greenhouse gas emissions.

In the academic cooperation, a concept of double PhDs and MSc studies has been established, meaning that NTNU and an international university both have students within related topics in order to ensure a close exchange and development of knowledge. Furthermore, many of the students have shorter or longer research exchange periods at a partner university. The Scientific Committee monitors the

academic production in order to benchmark the activity in an international perspective, as well as giving advice for further scientific focus and direction.

In addition to bilateral cooperation between academic partners, HighEFF has also implemented dedicated cooperation between academic partners and industry partners. This may for instance happen between SINTEF, NTNU, an international university and a specific industrial partner.

Due to the global spread of partners, regional meetings are also arranged. A workshop arranged at Doshisha university in 2020 is a good example of this. Academic partners from Japan and China, industrial partners from Japan and representatives from NTNU and SINTEF took part.

In December 2020, it was decided that NTNU and SINTEF will host the 15<sup>th</sup> IIR-Gustav Lorentzen Conference on Natural Refrigerants which will take place in 2022. This will be an important event for FME HighEFF and the ongoing research within utilisation of environmentally friendly refrigerants in industrial processes – and will increase the international attention received by HighEFF.



# Organisation

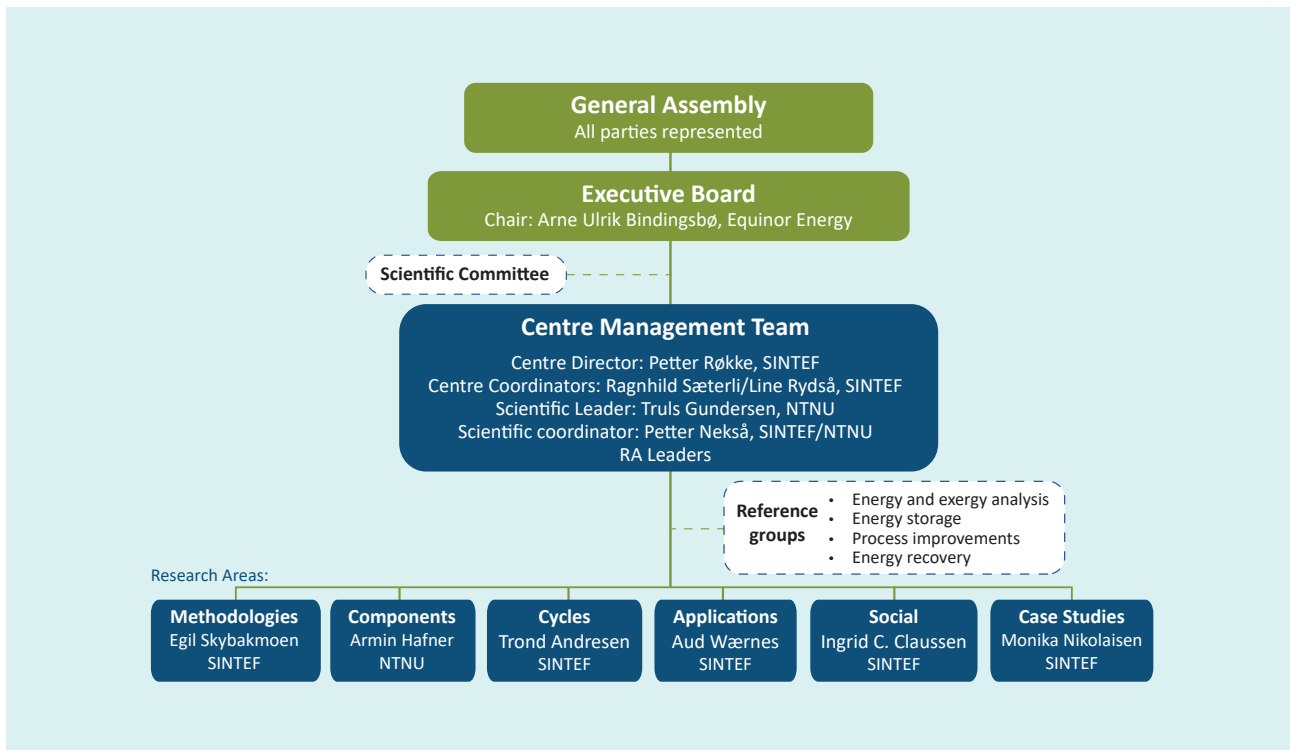

FME HighEFF is hosted by SINTEF Energy Research. The Centre Director is Petter E. Røkke. The General Assembly (GA) where all 26 industry partners, 13 research partners and the Executive Board Chair are represented, make all decisions that involve major changes to the consortium. Nancy Jorunn Holt (Hydro Aluminium) was appointed as the GA Chair at the first GA meeting in June 2017. The GA meets at least once a year.

## Executive Board

Arne Ulrik Bindingsbø (Equinor Energy) was appointed Chair of the Executive Board at the first GA meeting in June 2017. In addition to Arne Ulrik Bindingsbø, current members of the EB are John Barry (Hydro Aluminium), Edin Myrhaug (Elkem/Norwegian Ferroalloy Producers Research Association) Terje Lillebjerka (Mo Industripark), Øystein Fjørtoft (REMA 1000 Norge), Anders Sørhuus (GE Power Norway), Mona Mølnvik (SINTEF Energy Research), Nina Dahl (SINTEF Industry),

Terese Løvås (NTNU), and Per Morten Schiefloe (NTNU Samfunnsforskning). The EB usually holds four meetings a year.

## Scientific Committee

The HighEFF Scientific Committee is comprised of three national and three international experts. The mandate of the Scientific Committee is to provide advice on the relevance and quality of the



scientific activities for the Centre as a whole, as well as the individual Research Areas. In addition, they will highlight scientific trends, challenges and opportunities, and comment on how HighEFF performs relative to state-of-the-art (whether HighEFF research is world class or not). They will further provide strategic advice on scientific focus and priorities based on the performance of the various Research Areas and Work Packages. Robert C. (“Bob”) Armstrong, Director at MIT Energy Initiative, volunteered to act as Chair of the Scientific Committee. The other members are Ignacio E. Grossmann (Former Director CAPD at CMU), Megan Jobson (Professor at Univ. of Manchester), Tor Grande (Vice Dean Research at NTNU), Jack A. Ødegård (Vice President Research at SINTEF Industry) and Kristin Jordal (Research Manager at SINTEF Energy Research).

## Centre Management Team

The Centre Management Team (CMT) consists of the Centre Director Petter E. Røkke (SINTEF Energy Research), Centre coordinator Line Rydså and Acting Centre coordinator Ragnhild Sæterli (SINTEF Energy Research), the Scientific Leader Truls Gundersen (NTNU), Scientific Coordinator Petter Nekså (SINTEF Energy Research), and the six RA leaders. The RA leaders are Egil Skybakmoen (SINTEF Industry), Armin Hafner (NTNU), Trond Andresen (SINTEF Energy Research), Aud N. Wærnes (SINTEF Industry), Ingrid Camilla Claussen (SINTEF Energy Research) and Monika Nikolaisen (SINTEF Energy Research). The CMT handles the strategic and executive centre management, including issues relating to coordination between work packages, and centre performance. CMT arrange regular meetings as needed for coordinating the activities of the Centre. The Centre management reports to EB on scientific, technical, and financial matters as well as actual progress.



## Partners

### Research & Education Institutes



SINTEF Energy Research (Host)



Norwegian University of Science and Technology - NTNU



SINTEF AS (SINTEF Industry)



NTNU Samfunnsforskning AS



Nord University



SINTEF Ocean AS



KTH Royal Institute of Technology



Carnegie Mellon University



The University of Manchester



Shanghai Jiao Tong University



AIT Austrian Institute of Technology GmbH



Doshisha University



MIT Massachusetts Institute of Technology

### User Industry



Equinor Energy



Hydro Aluminium



Rema 1000



Eramet Norway



Norsk Alcoa



Elkem



Mo Industripark AS



Gassco



Orkla



Glencore Nikkelverk ASA



TINE SA



Vedde AS,  
member of TripleNine Group



Wacker Chemicals Norway AS



Finnfjord



Borregaard

Gether AS

Gether AS



Pelagia

---

### Vendors & Technology providers

---



Alfa Laval Corp AB



Danfoss AS



EPCON AS



GE Power Norway AS



Officine Mario Dorin



Parat Halvorsen AS



Mayekawa MFG Co., Ltd



Hybrid Energy AS



Cadio AS

---

### Enablers

---



ENOVA



Innovation Norway



# Innovations

## Innovation targets

The HighEFF ambition is to be a platform for innovation for energy efficiency in industry. Our innovation targets are to implement new and novel technology and knowledge, as well as to create value for the Norwegian industry through 15-20 new novel emerging concepts for energy and cost-efficient industry plants, heat recovery and use of surplus heat.

In addition, the ambitions are to:

- Shape the innovation strategies and technology roadmaps for the industry to ensure a consistent direction towards national and international energy- and emission targets
- Communicate centre activities and results internally, to stakeholders, legislator and to the public.
- Enhance the knowledge on barriers and enablers for collective innovation processes.
- Allocate funding for at least one Novel Emerging concept every year.

## How do we work with innovations in HighEFF?

The recommendations pointed out by the expert group "FME Innovation Task Force" in 2018 have been followed up by the HighEFF team in 2019 and onwards. Special attention has been given to systematisation and registration of innovations as well as visibility of innovations internally and externally.

In order to meet the innovation goals, set up by HighEFF, we have worked to facilitate for innovations through the following:

1. Defining criteria for what an innovation is
2. Dedicating an internal workshop to the topic innovation and presenting the actual innovations in HighEFF so far
3. Systematic reporting of innovations through Annual Work Plans (AWP), status reporting and communication internally and externally
4. Centre calls for Novel Emerging Concepts (NECs)
5. As part of one dedicated research area in HighEFF, RA5 Society, covering innovation strategies and enablers and barriers for innovation in FME Centres and in the point of intersection between research/ academia and industry.

HighEFF has adopted the following criteria and definitions of innovation: Innovation can be a product, a technology, a component, a process or a sub-process, a model or sub-model, a concept, an experimental rig or a service that is new or significantly improved with respect to properties, technical specifications or ease of use. Innovation can also be new application of existing knowledge or commercialization of R&D results. The innovation should be adopted by somebody or be ready for utilization provided that it is made probable that the innovation will be utilized within a limited timeframe.

When an HighEFF innovation is recorded, the probability of success and impact is evaluated simultaneously. If both criteria are high, the development of this innovation will continue with considerable effort.

Possible new ideas for innovations are examined by the management team yearly and the status of already registered innovations and those under development are updated. So far, 36 innovations have been



Photo: Mo Industripark AS

*The INTERCUR project focuses on a model-based approach to develop tools for evaluating the feasibility of integrated energy systems in future industrial clusters, using Mo Industripark (shown above) as a conceptual study.*

registered in HighEFF. Specific innovations covering reduced emission and energy consumption in industry processes are summed up in "one-pagers". Illustrative presentations are easy to communicate and have a broad impact.

The NEC scheme helps to strengthen innovation at the centre and allows for the development and testing of new ideas. The R&D partners can propose projects together with industry if possible, based on established criteria. Approximately 1.5 MNOK / year have been allocated for this scheme. So far, FME HighEFF has launched a total of 5 new NEC projects.

## Novel Emerging Concepts

To further emphasize innovation in HighEFF, and make room for new ideas, the yearly funding of Novel Emerging Concepts (NEC) will continue. In 2020, HighEFF funded two more NEC projects; (1) *Integrated Energy Systems for Industrial Clusters* (INTERCUR) and, (2) *Next generation casting process for the ferroalloy industry* (NECast)

The INTERCUR project focuses on a model-based approach to develop tools for evaluating the feasibility of integrated energy systems in future industrial clusters, using Mo Industripark as a conceptual study. The project includes current processes and energy flows, and the effect of including new business opportunities beneficial for surplus energy utilization is highly relevant for HighEFF.

The NECast project focuses on a conceptual approach for heat recovery from casting processes in the ferroalloy industry. When designing the next generation casting processes, dust collection and energy recovery should be considered simultaneously to avoid the risk of sub-optimisation. In addition, a new system should include improved instrumentation for better control of product quality and eliminate safety risks connected to pouring of molten metal. The project will demonstrate the viability of such a casting process.

Both projects will continue until May 2021.

## A selection of HighEFF's innovations

**1** HighEFF has developed a dairy with **38% less power demand** and **40% less GHG emissions**



**5** Pilot unit of novel cold thermal storage for food processing plants





# RESEARCH AND RESULTS



# Methodologies - RA1

The main objective of Methodologies is to improve existing – and develop new – methodologies for improved energy efficiency in industrial plants. We believe that technological enhancements are better drivers of innovation than cost reductions. For that reason, solutions that are thermodynamically more efficient will serve as our main driver. Also, changes in the framework conditions related to energy, environment, new technologies and markets are closely considered in our work.

## A summary of our work in 2020

The activities in RA1 are of fundamental character with a total of 6 PhD students (5 from March). The first HighEFF PhD student, Matias Vikse, defended his work in February: "A Nonsmooth Approach to Modeling and Optimization – Applications to Liquefied Natural Gas Processes and Work and Heat Exchange Networks". During his PhD period he and his co-authors have delivered *15 journal publications and 7 conference proceedings*. This also include a close co-operation between MIT and NTNU with one PhD student working on the same topic. There is also an international co-operation between UoM and NTNU with 2 PhD students. Professor Robin Smith from UoM actively co-supervises the PhD at NTNU. Here the topic is to explore energy storage technologies for the shift from fossil to renewable energy sources for future distributed energy hubs.

There have been some *partner involvements* worth mentioning this year. First, the work to investigate the potential for increased energy use and reduced CO<sub>2</sub> emissions at Mo Industrial Park. The work is important to optimise the cluster itself with respect to energy utilisation and environmental aspects but

also to include new activities (for instance bio-carbon production, post-consumption carbon capture or others). Results indicate that the energy recovery can be increased from *400 GWh to 640 GWh* at Mo Industrial Park. This work will continue in RA1 in 2021, partly in RA6, and also in the NEC INTERCUR project started autumn 2020.

The second partner involvements to be mentioned is process control systems of waste heat generated from Elkem Thamshavn. The work is based partly on the PhD student work by C. Kotiza, associate PhD Student D. Rohde, and resources from SINTEF Energy and the industrial partner Elkem. The work titled "Energy recovery from furnace off-gas: Analysis of an integrated energy recovery system by means of dynamic simulation" has been published. By introducing dynamic simulations tools, the integrated system for energy recovery from furnace off gas has been analysed. Preliminary results indicate an *increase in electricity generation of around 5%*.

The third topic is related to the Aluminium industry (Hydro, Alcoa and GE Power) where the key point is a critical evaluation of innovative ideas concerning the flue gas in aluminium electrolysis plants, focusing on the possibilities for increased heat recovery and increased concentration of carbon dioxide. The emission of CO<sub>2</sub> in Norway is around 2 Mton/year from the aluminium industry. However, the concentration of CO<sub>2</sub> is only 1 vol % and too low for eventual future CO<sub>2</sub> capture technology. Therefore, a concept involving recycling the gas and introducing heat exchangers and catalysts is under evaluation – illustrated in the figure. A workshop was arranged in May with around 30 participants. A paper was published at TMS in 2020, and close co-operation with the partners is established.



The Elkem Thamshavn factory in Orkanger.

The potential for increased heat recovery is huge in the aluminium industry (up to 1.8 TWh estimated in RA1 and RA6), and if part of this energy could be used in the CCS process it will enhance future developments

for CCS from Al electrolysis process in the future. But several technological issues need to be solved before implementation. We will address those topics in more detail in 2021 together with our industrial partners.

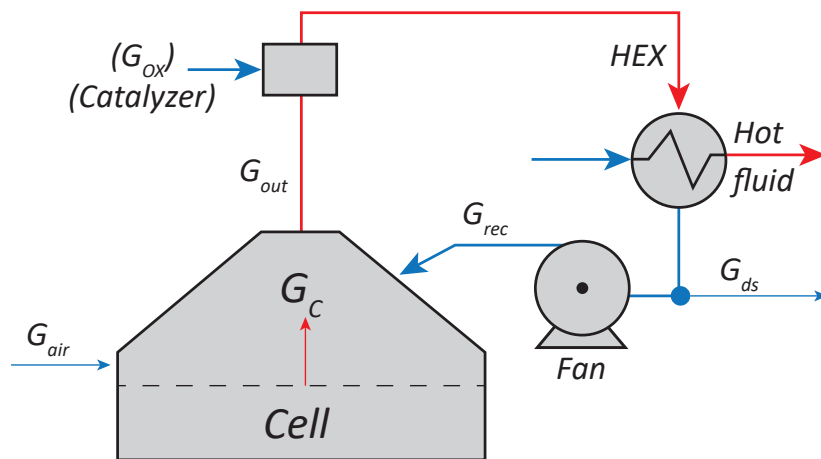

Sketch of recycling concept. Red: hot gas. Blue: cooled gas.



# Components – RA2

Our main objectives are to develop components required for cost-effective implementation of efficient systems for heat pumping and conversion. The focus is on heat exchangers, compressors and work recovery.

To achieve these goals, we develop methods and tools required for designing components. Focus is given to cycles with natural working fluid mixtures, thermodynamic properties, system optimization, and experimental development. The research area also performs design, support integration and maintains flexible component test facilities for the HighEFFLab infrastructure.

## RA2.1 Heat Exchangers

### VARGEO

In order to realise useful heat recovery from off-gas cooling, it is important to get the size of the large heat recovery heat exchanger (HRHE) to an acceptable level. Another issue is that the off-gas contains particles. The target is to design a heat exchanger that will have low velocities at the inlet, to avoid particles entering further into the heat exchanger – but for good heat transfer properties, the gas should accelerate once inside.

In 2020, we have worked in collaboration with WP4.2 (Surplus heat recovery) in HighEFF, which has given us the opportunity to study such a HRHE by extending the general heat exchanger modelling framework to

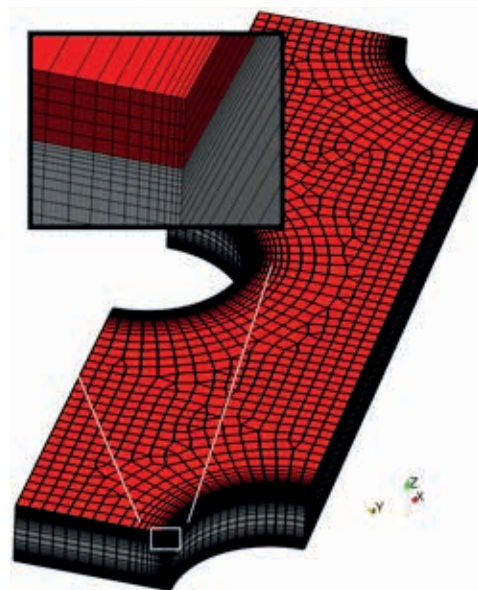
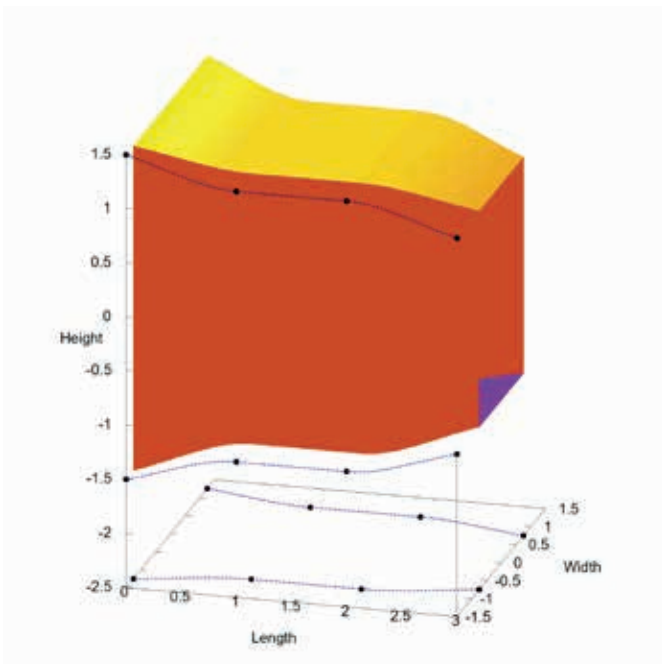



create a simulation model that allows the geometry to be adapted to the changes in the off-gas conditions. Research on how to obtain the optimal variable geometry will continue in 2021.

### CFD MODEL

Much of the work in WP2.1 is to develop models and methodology to study the simultaneous effects of process and heat exchanger geometry optimisation. The methodology depends on the underlying physical descriptions being valid over the operating range and on the models including the effects of all the geometry parameters subjected to optimisation. The underlying models are developed by laboratory measurements, but to be able to "measure" over a wider range of geometries these can be supplemented with Computational Fluid Dynamics (CFD). In 2020, we have established a link between the optimisation models and a CFD model, so that we can numerically verify the result. This led to a paper where we compared CFD results with literature data from experiments, and with results from the developed heat exchanger optimisation model using a traditional tube-in-fin heat exchanger as case.

## RA 2.2 Work Recovery & Compressors

The R&D focus is tuned towards compressors and technologies for expansion work recovery. The application of environmentally friendly and future proof natural refrigerants is a novelty of the research conducted by FME HighEFF. While the experimental investigation on the compressors was delayed due to covid-19, the modelling achieved a major step.

### COMPRESSORS

New compressors are under development having an extended operation envelope e.g.: towards higher temperatures. These compressors are paving the way for compact and reliable industrial high temperature heat pumps (HTHP) as applied in WP 3.2 (HTHP, Cooling and Drying). HTHP's delivering process heat up to 200°C will work with renewable energy and may cover up to 37% of all industrial process heat.

In WP 2.2 (Work Recovery & Compressors), a 3-dimensional dynamic ring plate valve model for reciprocating compressors, as applied in refrigeration, heat pump and HTHP applications, was developed. The model investigates the three-dimensional dynamics of the ring plate discharge valve, using loosely coupled computational fluid dynamics (CFD) and finite element method (FEM). The model was further compared to measurement results giving an insight into key elements of the compressor valve dynamics. The dynamic motion of the valve ring is controlled by the

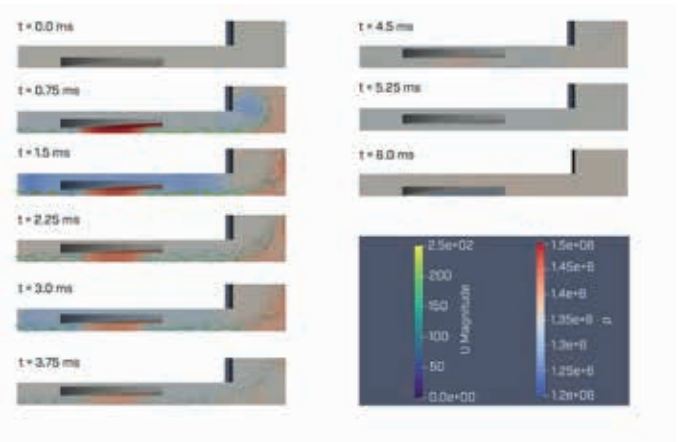

combined actions of forces resulting from applied pressure, spring reaction, impact with the valve's plate and cage, and damping effects. Future studies of these phenomena in greater depth will allow to understand the wearing of the valve and enable the compressor manufacturers to build more efficient and reliable compressors.

### EXPANSION WORK RECOVERY

The implementation of ejectors for expansion work recovery allows to increase efficiency and make environmentally friendly refrigeration systems more competitive. Investigations of the real system performance of an ejector-supported supermarket refrigeration system have been performed. 3 months of various system operation modes were analysed, concluding with an energy saving potential of about 10% when utilising the ejector technology in a real supermarket. Further improvements were identified, which have to do with heat recovery of the CO<sub>2</sub> based

refrigeration system. The largest benefits of the investigated systems are seen in warmer climates, such as southern Europe or India.

## Natural Working Fluids

Hydrocarbons as a 4<sup>th</sup> generation of working fluids has the capability to be utilised in many different applications, but in order to do so, hydrocarbon charge needs to be minimised to ensure safety. Internally enhanced tubes offer a possible solution, wherein the reduced volume minimises the charge. The critical design parameters such as pressure drop and heat transfer coefficient are unknown in these conditions. Experimental tests were performed at NTNU to measure these values in smooth and internally enhanced tubes. The results provide reliable prediction methods for design of heat exchangers. In the next steps, these predictive methods will be used for designing a heat exchanger in a predefined system.

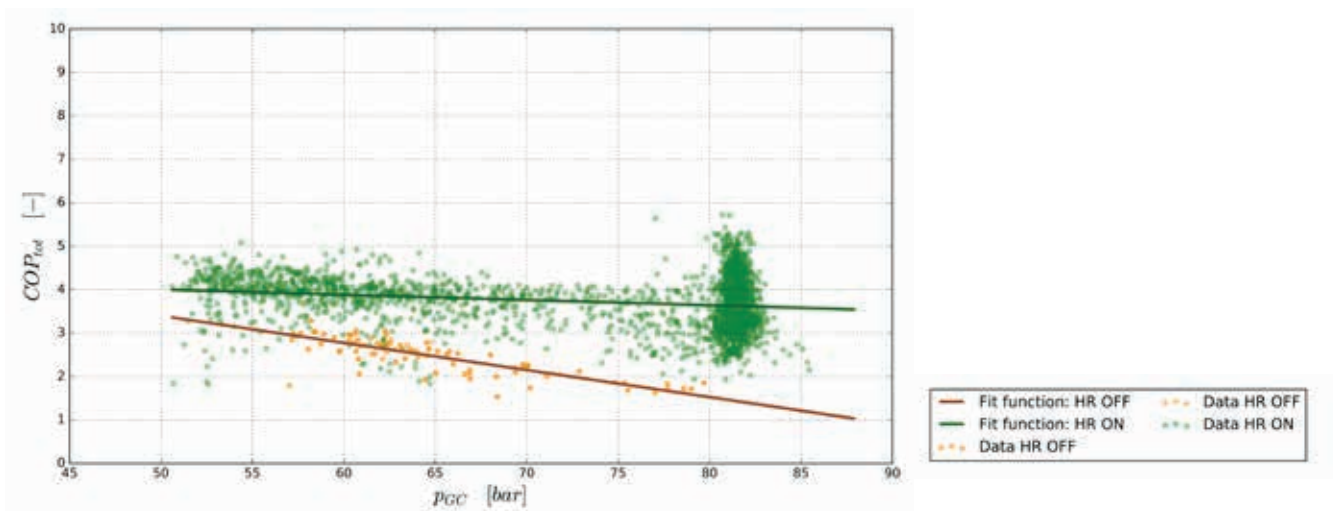



# Cycles - RA3

The overall goals are to develop improved cycles and concepts for converting and upgrading energy sources, including surplus-heat-to-power conversion, energy storage systems, and heat upgrade using heat pumps. Technologies and applications where HighEFF research has a large impact potential are emphasised.

Research in RA3 targets novel developments and improvements for important production processes across different industry sectors. A few example activities and results from 2020 are:

## Energy recovery from metal casting

The significant energy contained in liquid metal makes it an interesting source for energy recovery. This heat released during casting is difficult to utilise with current technology. Practical exploitation is further complicated by high temperatures, a highly dynamic process, and strict product quality requirements. The HighEFF research on novel concepts for metal casting energy recovery continued in 2020 with enhancing the dynamic system model to improve accuracy of the results and using the model to build an understanding of the complex relationships that will exist in future



industrial implementations. We are learning how to design practically feasible concepts that can extract more than 80% of the available heat and output a steady production of electric power. This also includes integration of tailored thermal storage solutions to smooth the intermittent heat input from the casting process, identification of components that must endure very high temperatures, and a general evaluation of remaining technology gaps. This work has been the basis for excellent cooperation with the metal producing partners in HighEFF – on technical aspects and how to develop the idea towards a practical industrial demonstrator. The activity resulted in a conference publication at Rankine 2020, and securing a linked Novel Emerging Concept project called NECast.

## High Temperature Heat Pumps for the industry

The potential of high temperature heat pump for decarbonising industrial heat was evaluated from a Norwegian as well as a European perspective by this White Paper: <https://www.sintef.no/globalassets/sintef-energi/industrial-heat-pump-whitepaper/2020-07-10-whitepaper-ihp-a4.pdf> titled: Strengthening Industrial Heat Pump Innovation – Decarbonizing Industrial Heat.

The work is based on different case studies and heat pump developments of HighEFF and outlines that industrial processes are currently responsible for 20 % of total greenhouse gas emissions in Europe. In order to stay within the 1.5°C scenario of the Paris Climate Agreement, measures to reduce these greenhouse gas

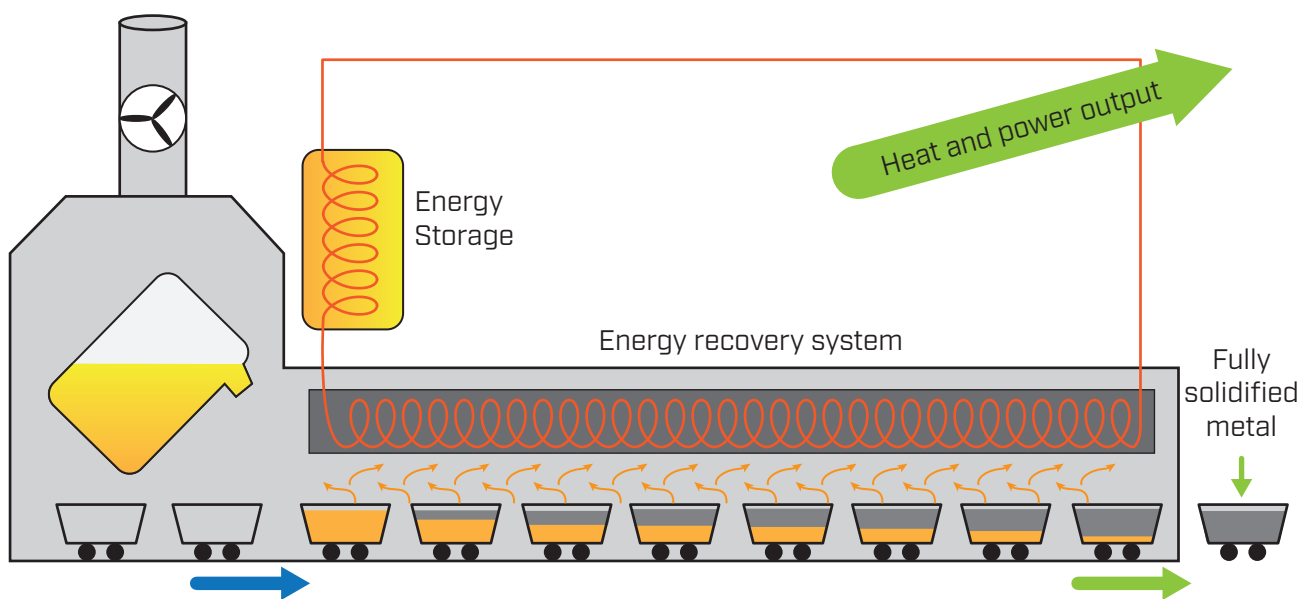

*Investigated concept for energy recovery from metal casting.*

emissions from industry are urgently needed. HighEFF highlights the role heat pump technologies can fulfil in realising significant reductions in CO<sub>2</sub> emissions arising from industrial process heating. Industrial heat pumps are a highly energy efficient, widely applicable technology to provide process heat. Driven by electric power, heat pumps are a key electrification technology which can replace a large share of fossil-fuelled industrial process heating.

A webinar with over 300 stakeholders was arranged in order to introduce the potential to a wider audience.

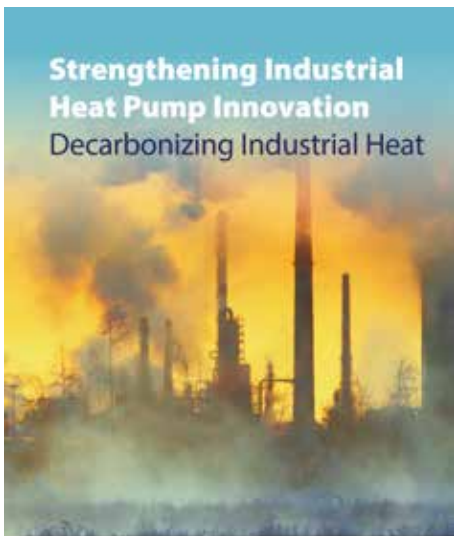

## Increased energy output from the heat recovery system at Elkem Thamshavn through thermal energy storage

Elkem Thamshavn, located in Orkanger, is an important local employer and a global vendor for advanced silicon products and Microsilica™. The plant recovers energy from the off-gas of two silicon furnaces for electricity generation and heat export. Unlike a power plant, the system is not optimised for maximum electricity generation. However, the energy output could be increased through a short-term energy storage in the form of a steam accumulator. An optimisation model was built to address the trade-off between gains from power generation and storage size/costs. Three different cases for steam storage integration – see illustration – were identified within the Elkem steam system: low-pressure steam line, low-pressure turbine, and high-pressure turbine. The results indicate that LP steam line feed-in is the most economical solution for use of surplus steam, and a storage size of 10 m<sup>3</sup> is recommended for implementation.

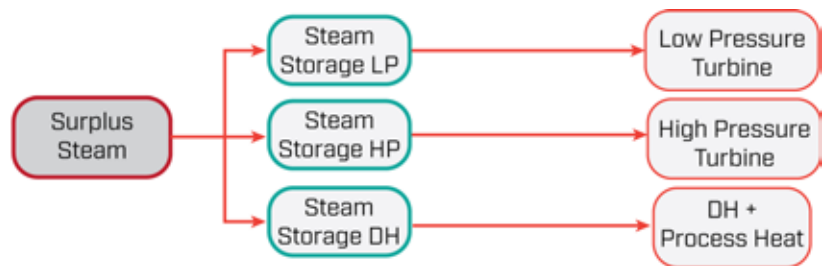



# Applications - RA4



We examine applications that will integrate basic research and concepts, components, and cycles developed in other RAs into specific industry settings. This is done to generate more energy-efficient processes and to improve heat capture and utilisation concepts.

## Process improvements

The off-gas from the silicon furnace has a very low concentration of CO<sub>2</sub>, which makes its capture difficult and expensive. By recycling parts of the off-gas back into the furnace, it is possible to raise the CO<sub>2</sub>-concentrations to higher levels. In HighEFF, this has been explored from a theoretical point of view, and the work has continued in 2020. Models show that NO<sub>x</sub> formation is suppressed under conditions of flue-gas recycle. PhD-student Vegar Andersen started in 2020 and will perform experiments investigating the effect of flue-gas recycle on microsilica-formation. Theoretical work from HighEFF has been instrumental in the design of a pilot-scale experiment that will be run in 2021 in a collaboration between several projects.

There are several different technologies available for CO<sub>2</sub> capture, which have different advantages and disadvantages relating to working concentrations of CO<sub>2</sub>, energy demands and others. A review of existing technologies has been performed to answer the request from industry to look at an evaluation of capture and utilisation of energy from metallurgical furnaces in a system where one of the energy outputs is towards CO<sub>2</sub> capture (e.g. amine regeneration), and the ultimate goal is an optimisation of the use of the recovered energy between electricity generation, CO<sub>2</sub>-capture, district heating, etc.

Another highlight of the year is the dissemination of PhD candidate Trine A Larssen, on the topic of "*Prereduction of Comilog- and Nchwaning ore*".

The off-gas from aluminium electrolysis is a significant source of surplus heat that is currently unused. Increased energy efficiency in this industry can be an important contribution to reducing the environmental footprint of the aluminium product. In order to make such investments, the industry requires cost- and space-efficient heat exchangers that can withstand the challenging conditions in the off-gas channels. In HighEFF, we have explored a modified plate-type heat exchanger concept without fins on the gas-side for this purpose. Previous simulations showed that this concept can be competitive both in terms of installation cost and compactness, which led to a conference paper and presentation at the Rankine 2020 Conference<sup>1</sup>.

New developments in the in-house heat exchanger modelling software at SINTEF Energy Research have made it possible to study any type of heat exchanger geometry. This improved model was in 2020 used to further investigate the "plate-no-fin" concept for aluminium smelter off-gas. We explored two different unconventional, non-constant geometries and showed that the heat exchanger weight can be further reduced at the expense of increased pressure drop. This trade-off between installation and operational cost will be further explored next year.

---

<sup>1</sup> Skjervold, V., et al. (2020). Enabling Power Production from Challenging Industrial Off-Gas - Model-Based Investigation of a Novel Heat Recovery Concept. <http://dx.doi.org/10.18462/iir.rankine.2020.1145>

## Visualisation of energy and material flows in an industry cluster

An interactive tool for visualising energy and material flows in an industrial cluster was created by a summer intern, NTNU-student Cosmin Aron. The work was supervised by researchers from the three SINTEF institutes Industry, Energy and Helgeland. The tool can be used for in-depth analysis of current synergies and by-product utilisation in an industrial cluster, as well as for improvements and integration of new actors. It

can also be useful for communication and promoting sustainability and good practices. It combines the simplicity of a diagram with more layers of information added through interactivity. The model was designed in Microsoft Visio and exported as an interactive webpage, with all the displayed data being imported from an external source (an Excel-file). The tool was applied for visualising the energy and material flows at Mo Industripark (MIP), as shown below

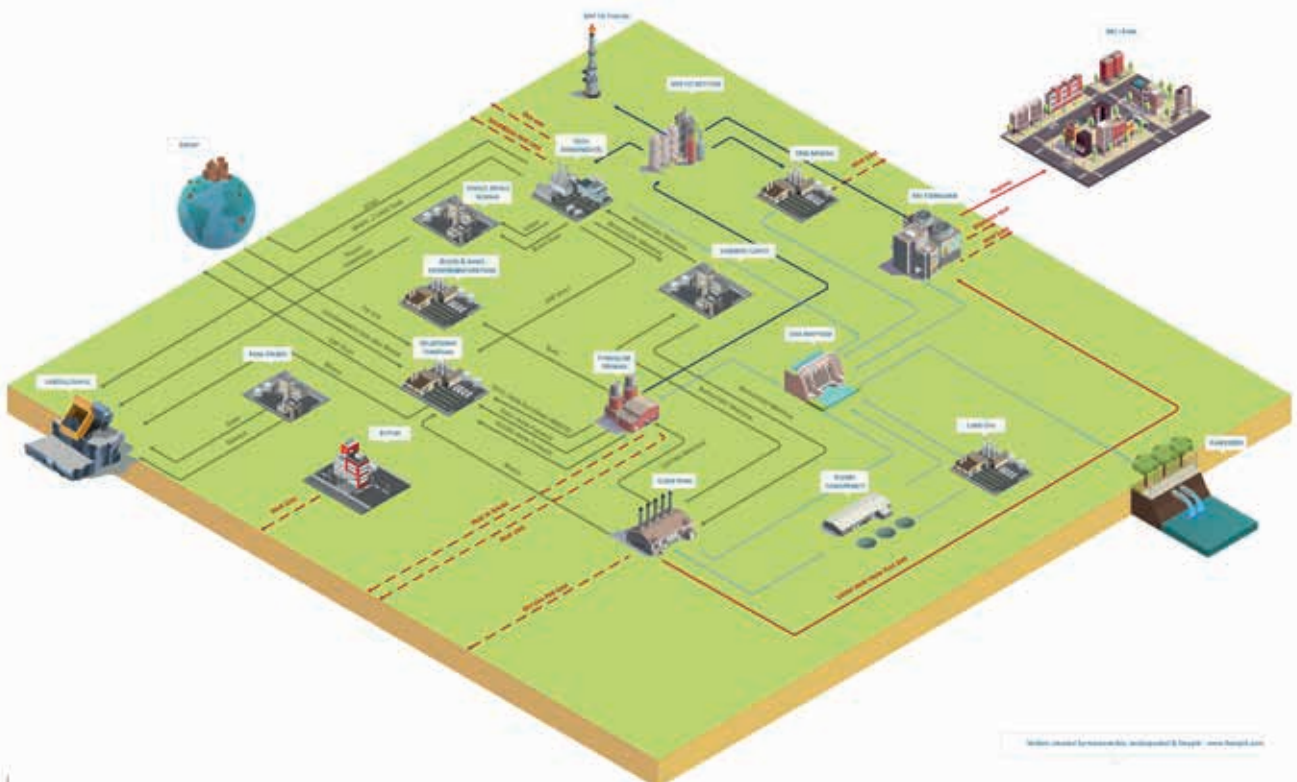

# Society - RA5

The overall aims are to manage the innovation activities and handle dissemination, communication and general flow of information in the Centre. Additionally, the goals are to form the innovation strategies and technological roadmaps for the industry sectors and share them among partners to enhance cooperation and synergies.

Innovation management includes research on internal and external interaction, as well as on the barriers and enablers for innovation and realisation of HighEFF technologies and concepts.

## Innovation, barriers and enablers

Through a close collaboration between NTNU Social Research and Nord University, we studied how researchers and companies collaborate in HighEFF to develop and implement radical energy efficiency innovations. We discovered that the interplay between collaboration dynamics in the research center and organisational factors can help explain why such innovations are (or are not) implemented, which led to a paper currently in review for the journal of cleaner production.

We provided research-based knowledge on how industry- and research partners manage to collaborate for the enhancement of knowledge and innovation. More precisely, we examined how companies coordinate in a research centre in early stages to achieve long term innovation benefits and which internal and external activities company representatives (boundary spanners) might engage in at various stages of a research centre. We also examined the role of proximity between companies and university partners in establishing successful

collaboration in a research centre and looked into additional effects from participating in university-industry collaboration that might be enhanced by companies. Moreover, we contributed with knowledge on how companies can manage the circular economy transition by getting involved in open innovation. To summarise, our research provides important insight to companies and research partners, about how to manage outcomes from university-industry collaboration; and to policymakers, about how such engagement should be funded and structured in order to reach goals of knowledge and innovation for environmental reasons.

## Novel Emerging Concepts (NEC)

New ideas and innovations are created through collaboration and research in HighEFF. Our internal funding scheme allow us to invest in ideas that are not planned for or that need more investigation before we know if they are worth bringing further. In 2020, 6 applications were received through our third internal novel emerging concept (NEC) call. The NECast and INTERCUR project received funding this year: the former focussing on improving heat recovery from casting processes in the ferroalloy industry and the latter concentrating on the development of evaluation tools for integrated energy systems in industrial clusters to achieve new business opportunities for surplus energy use.

## Dissemination and Communication

Our communication goals for 2020 have been to increase knowledge and awareness about energy efficiency in industry, through presenting its impact on sustainability and value creation, with increased use of social media and Newsletter.



Focus on visibility of the overall project results and the work performed in HighEFF have been followed up in HighEFF's communication strategy for 2020. Our strategy ensures widest- possible outreach, involvement and cross-sectorial interaction with relevant industry and academia. The dissemination strategy is built up to maximise the use of existing

physical meeting points (seminars, centre workshops and RA meetings) and existing communication platforms and media channels, such as project partners' existing communication channels.

For more details see the Communication chapter.







# Case Studies - RA6

Case Studies are performed to promote HighEFF innovations and obtain measurable results from the implementation of HighEFF technologies in the different industrial sectors. The overall goals for the case studies are to develop technology concepts that can lead to a 20-30% reduction in specific energy use and/or a 10 % reduction in CO<sub>2</sub> emissions through implementing technologies and solutions.

The energy savings at TINE dairy in Bergen were verified, and close to 40% energy savings were proven. The energy efficiency is still increasing and is likely to reach 50% or more when the dairy has been fine-tuned. This was achieved by integrating the heating and cooling demands at the dairy through heat pumps and thermal storage tanks. The overall energy flow over a week is presented in the figure. This is the first known dairy where all heating and cooling demands can be delivered by heat pumps, all the way from -1.5 °C to 95 °C. The results prove that the energy efficiency of industrial heating and cooling can be significantly

increased by focusing on energy savings already at the design phase of new plants. The systems used are also relevant for several other industries, both in Norway and Europe, and the work has been summarised in a journal paper currently under review by peers.

We performed a case study evaluating the system impact of heat-to-power conversion from smelter off-gas at a generic aluminium production facility. Results from the case study indicate that the power production potential not only depends on the energy content in the surplus heat source, but also on the conditions in the surrounding gas treatment system. The case forms a better basis for understanding the optimal integration of heat-to-power systems in the aluminium industry. The work has been published in the Energy journal<sup>2</sup>.

<sup>2</sup> <https://www.sciencedirect.com/science/article/pii/S0360544220320636>

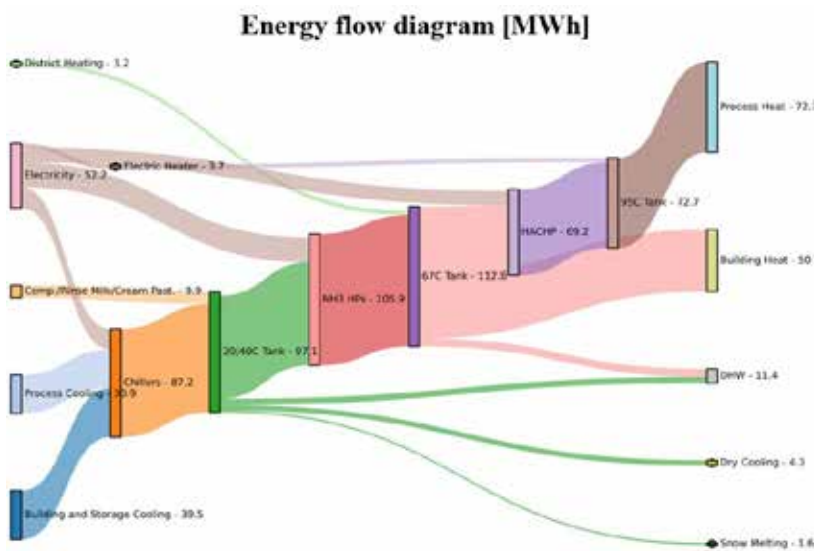

Sankey diagram visualizing process energy flow



# Research Infrastructure

The research infrastructure project HighEFFLab is moving towards the end, and most of the investments are already installed. The HighEFF Laboratory is ready and available!

HighEFFLab is a joint national laboratory between various departments at SINTEF and NTNU. The facilities are mainly located at the NTNU Gløshaugen campus in Trondheim except for one installation situated at SINTEF Energy Lab at Blaklia. HighEFFLab is a national research infrastructure and aims to be the leading platform for experimental research within industrial energy efficiency through the operation of unique and excellent laboratory facilities. The research infrastructure is accessible for all industry, research and academia interested in experimental testing of components, processes or products related to our areas of research.

HighEFFLab consists of six laboratories, with a total of 12 experimental rigs and 8 analysis instruments. In addition, tools for calibration and field measurements, and computers and software for designing, modelling and simulations, are also part of this infrastructure. The HighEFFLab laboratories are:

1. The Heat Exchanger Laboratory
2. The Expander Tests Laboratory
3. The Natural Refrigerants Laboratory
4. The Dewatering Laboratory
5. The Gas and Material Characterization Laboratory

An extensive renovation of several laboratory areas was completed in 2019, and a brand new analytical and calibration laboratory is ready for use. The structural upgrading at VATL includes the extension of the cooling water supply, installation of a new transformer together with distribution cabinets, and ATEX approved ventilations. The available area has been expanded by building a mezzanine of approximately 60m<sup>2</sup> to house the new heat exchanger rig and the expander test rig. Due to the covid-19 pandemic, assembly of the two installations is delayed. The work will continue into 2021 with a view to be ready for testing before the summer of 2021.

For further information on available instruments and test facilities, please visit the website:

[www.sintef.no/highefflab](http://www.sintef.no/highefflab)



# Spin-off projects

Year	Short title	Full title	Collaborating partners	Research program	Project type
2017	Free2Heat	Emission free industry: Development of efficient two-phase compressor as replacement for fossil energy	ToCircle	Energix	IPN
2017	Rockstore	Rockstore - develop, demonstrate and monitor the next generation BTES system	CMR vertskap	Energix	KPN
2017	COMPACTS2		ConocoPhillips, AkerBP	Petromaks2	KPN
2017		Reduced CO <sub>2</sub> emissions in Metal Production	...	Energix	KPN
2017	LTTG+	Low-temperature thermal grids with surplus heat utilization	NTNU, Statkraft Varme, Dora AS, Fortum Oslo Varme AS	EnergiX	KPN
2017	CleanTex		Nortekstil	Energix	IPN
2017	EnTrain		Norske Tog AS, NSB	Energix	IPN
2017		Climate-friendly asphalt production from district heating	Veidekke AS, FØRDEFJORDEN ENERGI AS	RFF	
2017		Combination of new and future oriented energy solutions	Rørosmeieriet	ENOVA	
2018	BioCarbUp	Optimising the biocarbon value chain for sustainable metallurgical industry	NIBIO, NTNU, SINTEF Industry	EnergiX	KPN
2018	COOLFISH	Energy efficient and climate friendly cooling, freezing and heating onboard fishing vessel	SINTEF Energy, SINTEF Ocean, NTNU ++	MAROFF	KPN
2018	SkaleUP	Sustainable and efficient heat pump development for combined process heat and cool	Skala fabrikk	EnergiX	IPN
2018	BioCirc	BioCirc - a circular economy approach to biocarbon production	SINTEF Industry, SINTEF Energy	RFFNord	RFF
2019	NorGiBaF	Norwegian Giga Battery Factories	SINTEF Energy ++	EnergiX	KPN
2019	PCM Store	PCM-based low temperature thermal energy storage for a more sustainable food industry	NTNU ++	EnergiX	KPN
2019	ECOCHINO		NTNU, SINTEF Industry, UiT	EnergiX/ CHINOR	FP
2019	Edu-Cool	Educational program for sustainable heating and cooling solutions for India	SINTEF Energy, NTNU ++	INTPART	
2019	LowPass	Low Emission Passenger Ships	Fosen Design & Solutions	MAROFF	IPN
2019	IntER-COLD	Interdisciplinary Education and Research Platform in Cold-chain of Fish	SINTEF Energy, NTNU ++	INTPART	





Year	Short title	Full title	Collaborating partners	Research program	Project type
2020	Applications				
	DEXPAND		Czech Techn univ	KAPPA	EEA grants
	SUPAWIN	Superior Anodes for Energy Efficient and Low CO <sub>2</sub> Aluminium	SINTEF Industry	EnergiX	KSP
	ADVENS	Advanced energy recovery systems for climate neutral ferroalloy production	SINTEF Energy	EnergiX	KSP
	MHD Jet	Low-temperature power cycles without moving parts based on ejector-driven magnetohydrodynamic electric generator	SINTEF Energy	EnergiX	Rad nye
	CELLWIN	Cell Performance for Energy Efficient and Low CO <sub>2</sub> Aluminium Electrowinning	SINTEF Industry	EnergiX	KSP
	InterPort	Integrated energy systems in ports	SINTEF Energy	EnergiX/ MAROFF	KSP
	AGATE	Advanced Gas Treatment in Aluminium Electrolysis	GE	EnergiX?	IPN
	HighEFFLab+	HighEFF lab extension	SINTEF Energy	INFRA- STRUKTUR	INFRA
	TEMP	Infrastructure for metal industry applications	SINTEF Industry	INFRA- STRUKTUR	INFRA

# Education, researcher training and recruitment

Developing knowledge and expertise at various levels is a main objective and major task in HighEFF. The focus is on energy efficiency in industrial processes, and the main sub-activities are (i) methodologies for analysis, design and optimization, (ii) improved equipment and cycles, and (iii) systems integration including industrial parks (clusters). The education activity takes place at different levels: Master students having theses related to HighEFF; PhDs and Postdocs with research and publications related to energy efficiency in industry; and employees from user partners taking tailormade intensive courses to become energy efficiency experts in their companies.





Photo: Maxime Landrot/NRW





By the end of 2020, HighEFF had recruited a total of 24 candidates (19 PhDs, four Postdocs and one researcher). The last PhD position has been announced and the candidate is set to start in the first quarter 2021. Two PhDs and one Postdoc finished in 2020. We also have had nine associated PhDs (which means that they are working on HighEFF related topics), and one of these finished in 2020.

Our education program also spans across countries and continents. HighEFF academic partners currently include two from Norway (NTNU and Nord University), two more from Europe (KTH in Sweden and University of Manchester in the UK), three in the US (MIT, CMU and University of Illinois) and two in Asia (Shanghai Jiao Tong University in China and Doshisha University in Japan) – a total of nine universities.

The considerable number of recruited candidates resulted in a large number of publications and conference presentations. HighEFF had 43 journal

publications and 32 conference presentations in 2020 (the 1<sup>st</sup> is “all time high”, the 2<sup>nd</sup> was affected by Covid-19) with at least one of the recruited candidates as author/co-author. The candidates received Best Review Paper Award (Assoc. PhD Avinash Subramanian in Journal Processes), Best Student Paper Award (Brede Hagen at the IIR Rankine Conference, and 2<sup>nd</sup> Best Young Speaker Award (PhD Zhongxuan Liu at PRES'2020).

## PHDs, Postdocs and Master Students

With an early recruitment start in HighEFF, the PhDs and Postdocs have already spent around 75% of the time and funding available for their research. A large number of candidates is expected to finish in 2021, with more following in 2022. Master students are also contributing to the research in HighEFF, and 11 Master's theses were submitted in 2020 – the highest number so far in HighEFF.



Photo: Maxime Landrot/NTNU

# Communication

Reaching HighEFF's vision of making Norwegian industry the world's cleanest requires sharing new knowledge and information to industry. It also requires industrial and political willingness as well as public acceptance. Communication is therefore a core strategic activity of HighEFF.

Communication activities extend beyond the HighEFF consortium and scientific community to provide facts about energy efficiency and promote innovations to industry.

In 2020, the pandemic forced us to use digital communication to an even greater extent than before.

## Visibility

In order to reach a wide audience (both within and outside of the consortium) HighEFF has contributed to media coverage of energy efficiency in industry. In total, HighEFF had 22 media contributions, 11 blogs and information material and several multimedia products in 2020.

## Web

The HighEFF website provides information about the centre and its activities and is continuously updated as needed. It had 1491 web sessions in 2020.

2020 Numbers from CRISTin (Current Research Information System in Norway)

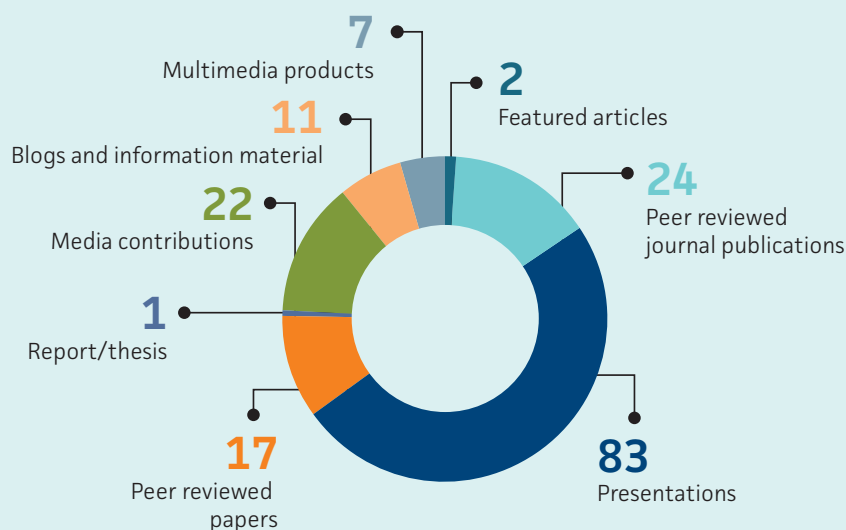

## Key Performance Indicators for communication activities in FME HighEFF

Below is a simplified graphic representation of the FME HighEFF Communication plan. To better monitor the effects of the Centre’s communication work, new KPIs were established in January 2019.



### Communication strategy

Vision	Why? FME Goal	Who? Target groups	What? Message	How? Channel/media	Results
 <p>By increasing energy efficiency, HighEFF will help ensure that Norway has the world's greenest industries.</p>	<p>In order to become a success in:</p> <ul style="list-style-type: none"> <li>research activity</li> <li>innovation/value creation</li> <li>internationalisation</li> <li>training/recruitment</li> <li>funding</li> <li>organisation</li> </ul>	<ul style="list-style-type: none"> <li>Industry</li> <li>Politicians</li> <li>Funding parties: RCN/EU+</li> <li>Public/NGOs</li> <li>Partners in the centre</li> <li>International research organisations</li> </ul>	<ul style="list-style-type: none"> <li>The world needs energy efficiency to achieve clean industry</li> <li>HighEFF will ensure that Norway has the world's greenest industries</li> <li>HighEFF will increase value creation in Norway</li> </ul>	<ul style="list-style-type: none"> <li>Webpage</li> <li>Scientific dissemination</li> <li>#SINTEFblog</li> <li>Media</li> <li>Events</li> <li>Newsletter</li> <li>Annual report</li> <li>SoMe</li> <li>Webinars</li> </ul>	<p>KPI: Increased visibility and knowledge</p> <p>KPI: Increased positive reputation</p> <p>KPI: Increased internal engagement</p> <p>Achieving FME goals</p>
← evaluation - reporting - learning →					

## CHARGE Energy Awards

SINTEF was recognised by the CHARGE Energy Awards for its strategic approach to branding and communications, of which the strategy and plan developed and implemented for HighEFF played a part.





## Key Performance Indicators

Goal	KPI	2016	2017	2018	2019	2020	
Increased visibility and knowledge	Media clips in Cristin	7	2	3	5	22	●
	Op-Eds	3	0	2	0	2	●
	Information material incl. Blogs in Cristin	7	13	11	15	11	●
	Multimedia product in Cristin (Sound and video)	0	0	23	9	7	●
	Video views (FB, Twitter, YouTube)	0	977	8058	46 469++	48 620++	●
	Twitter views	*	*	*	25 656	16 000	●
	Blog views	*	1339	2445	4234	2446	●
	New users on web on higheff.no	20**	138	401	534	838	●
	Number of web sessions on higheff.no from referrals and social	38**	35	288	294	446	●
	Number of web sessions on higheff.no	46**	472	1067	1346	1491	●
	Newsletters opening rate %	*	*	*	44,9	58,8	●
	Newsletters click rate %	*	*	*	9,6	13,95	●
Increased positive reputation	Twitter followers	*	*	*	91	114	●
	Retweets	*	*	*	29	23	●
	Likes (Twitter)	*	*	*	58	23	●
	Link clicks (Twitter)	*	*	*	49	49	●
	Engagement frequency (Twitter)	*	*	*	1,4	2,1	●
	Retriever Pulse "hits" (several social media sources)	0	0	1	44	20	●
Increased internal engagement	Number of blog authors	2	7	6	12	8	●
	Newsletters sent	0	4	4	8	6	●

+ <https://www.mailpoet.com/blog/how-to-improve-your-email-open-rates/> <https://www.mailpoet.com/blog/how-to-improve-your-click-rates/>

++ 46.000 views from sponsored post.

\*No data available

\*\*Web established summer of 2016

# Appendix

## Key researchers

### Key researchers in HighEFF

Name	Institution	Main research area
Adriana R Lua	SINTEF Energy	Industry clusters
Afaf Saai	SINTEF Industry	FEM modelling, WP2.2
Alexis Sevault	SINTEF Energy	High-temperature TES for industrial processes
Amin Azar	SINTEF Industry	NEC HighEX
Ángel Pardiñas	SINTEF Energy	Expander test laboratory
Anton Beck	Austrian Institute of Technology	Steam thermal storage
Armin Hafner	NTNU	High temperature heat pumps, cold thermal storage
Arne Petter Ratvik	SINTEF Industry	Novel emerging concepts
Asbjørn Solheim	SINTEF Industry	Chloride Al processes, inert anode, HH improvement, Case study Al
Asle Gauteplass	NTNU Social Research	Society - NEC shared resources and alternative business models
Aud N Wærnes	SINTEF Industry	Process improvements
Avinash Subramanian	NTNU	Polygeneration systems for chemical and energies
Balram Panjwani	SINTEF Industry	Process improvements
Bin Hu	Shanghai Jiao Tong University	Steam high temperature heat pump
Brage Knudsen	SINTEF Energy	Thermal energy storage potential for the industry, modelling and optimization of energy exchange in clusters. Industrial cluster case studies and measurement of HighEFF overall goals.
Brede Hagen	NTNU	Surplus heat-to-power conversion
Catharina Lindheim	NTNU Social Research	Society - NEC shared resources and alternative business models
Cecilia Gabrielli	SINTEF Energy	Low temperature cooling, steam production aluminum industry
Christian Schlemminger	SINTEF Energy	High temperature heat pumps and thermal energy storage for industrial processes
Cristina Zotica	NTNU	Optimal Operation and Control of flexible Heat-to-Power Cycles
Daniel Rohde	SINTEF Energy	Energy-to-power conversion, and Industry clusters and technology integration
David Perez Pineiro	NTNU	Optimal operation and control of energy storage systems
Egil Skybakmoen	SINTEF Industry	RA1 Methodologies leader. HH improvements, Case study Al, Surplus Heat recovery Al
Ehsan Allymehr	NTNU	Heat transfer and pressure drop in small diameter pipes for natural working fluids and mixtures
Einar Jordanger	SINTEF Energy	Management
Einar Rasmussen	Nord Universitet	Supervisor Irina Isaeva
Espen Verpe Halvorsen	SINTEF Energy	Heat pumps, cooling and drying



Name	Institution	Main research area
Gabriella Tranell	NTNU	Recycling of furnace gas, supervisor for Vegar Andersen
Geir Skaugen	SINTEF Energy	Heat exchangers
Gerwin Drexler-Schmid	Austrian Institute of Technology	High-temperature thermal energy storage, High Temperature heat pumps
Goran Durakovic	SINTEF Energy	Surplus heat-to-power conversion, RA6 case studies; industry clusters
Gudveig Gjøsund	NTNU Social Research	Organizational analysis
Halvor Dalaker	SINTEF Industry	Process improvements
Han Deng	SINTEF Energy	Heat exchangers, natural working fluids
Hanne Kauko	SINTEF Energy	Thermal energy storage (TES) potential in industry clusters, High-temperature TES for industrial processes, Industrial Clusters
Haoshui Yu	NTNU	Work and Heat Integration, ORCs
Helle Børset Eidissen	SINTEF Energy	Heat exchangers
Hiroshi Yamaguchi	Doshisha University	Refrigeration technology
Håkon Fyhn	NTNU Social Research	Future success factors of industrial clusters
Håkon Selvnæs	NTNU	Cold thermal storage for industrial applications
Ida Teresia Kero	SINTEF Industry	Metallurgy, materials science, process improvements
Ingeborg Solheim	SINTEF Industry	Casting case study
Ingrid Camilla Claussen	SINTEF Energy	Dissemination, society
Irina N. Isaeva	Nord Universitet	Industry/University collaboration for environmental innovations
Ivar S. Ertesvåg	NTNU	Exergy Analysis of Offshore Oil & Gas Processing Systems
Jason Foulkes	NTNU	Master student oil and gas case studies
Jens Olgard Dalseth Røyrvik	NTNU Social Research	Societal, social and organizational conditions for energy efficiency
Jens Petter Johansen	NTNU Social Research	Barriers and enablers for energy- efficiency and exchange
Jingwei Zhu	University of Illinois	Vortex Control for Two-phase Ejectors and other Expansion Devices
Johannes Jäschke	NTNU	Optimization of Energy Efficiency in large-scale Industrial Systems under Uncertainty
Juejing Sheng	NTNU	Exergy Analysis of Offshore Oil & Gas Processing Systems
Julia Jimenez Romero	The University of Manchester	Reduction of Industrial Energy Demand through Sustainable Integration of distributed Energy Hubs
Julian Straus	SINTEF Energy	RA6 case studies; industry clusters
Karl Erik A Lindqvist	SINTEF Energy	Heat exchangers
Knut Emil Ringstad	NTNU	CFD for improving components of R744 vapor compression units
Kristian E. Einarsrud	NTNU	Industrial clusters
Kristian Leonard Aas	SINTEF Industry	Thermo electric generation
Kristina Norne Widell	SINTEF Ocean	HTHP, Cooling and Drying and Case studies food



Name	Institution	Main research area
Lars O. Nord	NTNU	Supervisor
Leiv Kolbeinsen	NTNU	Industrial clusters
Line Rydså	SINTEF Energy	Management
Lorenz T. Biegler	Carnegie Mellon University	Supervisor Siaf Kazi
Lucia Liste	NTNU Social Research	Society - NEC shared resources and alternative business models
Mandar Thombre	NTNU	Optimization of Energy Efficiency in large-scale Industrial Systems under Uncertainty
Marcel Ahrens	NTNU	High temperature Hybrid heat pump
Marcin Pilarczyk	NTNU	Compact bottoming cycles for offshore power production
Marianne T Steinmo	Nord Universitet	Industry/research collaboration in FME centres
Matias Vikse	SINTEF Energy	Development of Optimization Models for Work and Heat Exchange Networks, NEC INTERCUR
Merete Tangstad	NTNU	Energy Distribution in Mn-alloy Furnaces
Michael Bantle	SINTEF Energy	High temperature heat pump (HTHP), low temp cooling next gen drying systems, food and chemical case studies
Michael Jokiel	SINTEF Energy	Seasonal thermal energy storage
Michael Lauermann	Austrian Institute of Technology	High Temperature Heat Pump
Michael Schöny	Austrian Institute of Technology	NEC CETES
Mina Shahrooz	Kungliga Tekniska Högskolan	Low temperature waste-heat-to-power conversion
Monika Nikolaisen	SINTEF Energy	Surplus heat-to-power conversion, oil, gas and energy case studies
Morten Dahle Selfors	Nord Universitet	Society
Olaf Trygve Berglihn	SINTEF Industry	KPIs, energy & exergy analyses, process improvements
Ole H Meyer	SINTEF Energy	RA2 Components
Ole Kjos	SINTEF Industry	Surplus Heat recovery AI
Ole Marius Moen	SINTEF Energy	High temperature heat pump
Paul I Barton	Massachusetts Institute of Technology	Supervisor Suzane Cavalcanti
Per Lundqvist	Kungliga Tekniska Högskolan	Supervisor Mina Shahrooz
Per M. Schiefloe	NTNU Social Research	Innovation
Petter Nekså	SINTEF Energy/NTNU	Energy efficiency in industry
Petter Røkke	SINTEF Energy	Management
Ragnhild Sæterli	SINTEF Energy	Management
Rahul Anantharaman	SINTEF ER	Oil and gas case studies
Roberto Agromayor	NTNU	Turbomachinery for waste heat recovery applications



Name	Institution	Main research area
Robin Smith	The University of Manchester	Reduction of Industrial Energy Demand through Sustainable Integration of distributed Energy Hubs
Saif Rahaman Kazi	Carnegie Mellon University	Optimization of Multi-Stream Heat Exchangers with Phase Change
Samuel Senanu	SINTEF Industry	HH improvement, Gas recycling AI cells.
Sander Holum	NTNU	Summer researcher oil and gas case studies
Signe Kjelstrup	NTNU	Establish KPIs with Focus on Energy Efficiency in HighEFF
Sigurd Skogestad	NTNU	Process systems engineering
Silje Marie Smitt	NTNU	HVAC systems in high performance buildings
Stefan Andersson	SINTEF Industry	Process improvements
Stefan Elbel	University of Illinois	Supervisor Jingwei Zhu
Stefanie Blust	NTNU	Detector cooling with R744 refrigeration technology
Suzane Cavalcanti	Massachusetts Institute of Technology	Nonsmooth Approaches for Process Flowsheet Simulation and Optimization
Sverre Foslie	SINTEF Energy	High temperature heat pumps and thermal energy storage for industrial processes
Tom S. Nordtvedt	SINTEF Ocean	HTHP, Cooling and Drying and Case studies food
Trine A Larssen	NTNU (mnd 1-9)	Energy Distribution in Mn-alloy Furnaces
Trine A Larssen	SINTEF Industry (mnd 10-12)	Process improvement Mn
Trond Andresen	SINTEF Energy	Surplus heat-to-power conversion
Truls Flatberg	SINTEF Industry	NEC INTERCUR
Truls Gundersen	NTNU	Pinch and Exergy analyses, low temperature processes
Trygve Eikevik	NTNU	Natural refrigerants
Vegar Andersen	NTNU	Recycling of furnace gas
Vidar Skjervold	SINTEF Energy	Surplus heat recovery
Xiang Ma	SINTEF Industry	NEC HighEX
Zawadi Mdoe	NTNU	Optimal control for industrial processes under uncertainty
Zhongxuan Liu	NTNU	Modeling and Optimization for the Design and Operation of a Network of Distributed Energy Hubs
Åsmund Ervik	SINTEF Energy	RA2 components, work recovery and compression

## Visiting researchers

### Visiting researchers\*

Name	Affiliation	Nationality	Duration	Topic
Thomas A. Adams	McMaster University, Hamilton, Canada	USA	Aug - Dec 2017	Optimization under uncertainty
Natalya Kizilova	Warsaw University of Technology, Poland	Ukraine	Apr - Dec 2019	Minimum entropy production in energy systems
Youngsub Lim	Seoul National University	South Korea	Feb - Oct 2020	Boil-off gas handling in LNG transport
Lorenz T. Biegler	Carnegie Mellon University	USA	Sep - Oct 2020	Plant-wide optimization

## Postdoc

### Postdoctoral researchers with financial support from the Centre budget

Name	Nationality	Period	Sex	Topic
Elisa Magnanelli	Italy	05 2017 - 04 2019	F	Establish KPIs with Focus on Energy Efficiency in HighEFF
Haoshui Yu	China	04 2017 - 03 2019	M	Thermodynamic Approach to Work and Heat Exchange Networks
Håkon Fyhn	Norway	11 2017 - 10 2021	M	Future success factors of industrial clusters (PD/Researcher)
Àngel Àlvarez Pardini	Spain	05 2018 - 05 2020	M	Expander Test Laboratory
Marcin Pilarczyk	Poland	07 2018 - 07 2021	M	Compact and efficient bottoming Cycles for offshore Power Production

## PhD students

### PhD students with financial support from the Centre budget

Name	Nationality	Period	Sex	Topic	Completed?
Brede A. L. Hagen	Norway	08 2018 - 08 2021	M	Power production from medium temperature heat sources	No
Cristina Zotica	Romania	08 2017 - 06 2021	F	Optimal Operation and Control of flexible Heat-to-Power Cycles	No
David Pérez Piñeiro	Spain	08 -2019 - 08-2022	F	Optimal operation and control of energy storage systems	No
Ehsan Allymeh	Iran	07 2018 - 07 2022	M	Heat transfer and pressure drop in small diameter pipes for natural working fluids and mixtures - Measurement and modelling	No



Name	Nationality	Period	Sex	Topic	Completed?
Håkon Selvnes	Norway	08 2017 - 06 2021	M	Cold Thermal Energy Storage for Industrial Applications	No
Irina Nikolayevna Isaeva	Norway	01 2018 - 12 2021	F	Industry/University collaboration for environmental innovations	No
Jens Petter Johansen	Norway	09 2017 - 06 2021	M	Barriers and enablers for energy-efficiency and exchange	No
Juan Cristancho	Colombia	06 2017 - 02 2018	M	Compact and efficient bottoming Cycles for offshore Power Production	Terminated
Juejing Sheng	China	09 2017 - 02 2022	F	Exergy Analysis of Offshore Oil & Gas Processing Systems	No
Julia Jimenez Romero	Ecuador	10 2017 - 03 2021	F	Reduction of Industrial Energy Demand through Sustainable Integration of distributed Energy Hubs	No
Knut Emil Ringstad	Norway	08 2018 - 08 2021	M	CFD based calculation tools for improving components of R744 vapor compression units	No
Mandar Thombre	India	08 2017 - 12 2020	M	Optimization of Energy Efficiency in large-scale Industrial Systems under Uncertainty	No
Matias Vikse	Norway	08 2016 - 12 2019	M	Development of Optimization Models for Work and Heat Exchange Networks	Yes
Mina Shahrooz	Iran	05 2017 - 04 2020	F	Low Temperature Power Cycles for Waste Heat utilization with Mixtures of natural Fluids	No
Saif Rahaman Kazi	India	01 2017 - 12 2020	M	Optimization of Multi-Stream Heat Exchangers with Phase Change	No
Suzane Cavalcanti	Brazil	06 2017 - 05 2021	F	Nonsmooth Approaches for Process Flowsheet Simulation and Optimization	No
Trine Askund Larssen	Norway	08 2017 - 07 2020	F	Energy Distribution in Mn-alloy Furnaces	No
Vegar Andersen	Norway	01-2020 - 12-2022	M	Recirculating of furnace offgas	No
Zhongxuan Liu	China	09 2018 - 10 2022	F	Modelling and Optimization for Design and Operation of a Network of Distributed Energy Hubs	No

## PhD students working on projects in the centre with financial support from other sources

Name	Funding	Nationality	Period	Sex	Topic	Completed
Adriana Reyes Lúa	NTNU	Mexico	09 2016 - 08 2019	F	Optimal Operation and Control of Vapor Compression Cycles	Yes
Julian Straus	Yara/ NTNU 50/50	Germany	09 2016 - 03 2018	M	Minimizing Energy Consumption in an Ammonia Plant by Optimal Operation	Yes
Avinash Subramanian	NTNU	India	09 2017 - 08 2021	M	Optimal Design and Operation of Polygeneration Production Chains	No
Daniel Rohde	KPN INTERACT	Germany	09 2016 - 12 2018	M	Dynamic Simulation of Future Integrated Energy Systems	Yes
Roberto Agromayor	KPN COPRO	Spain	01 2017 - 07 2020	M	Turbomachinery for Waste Heat Recovery Applications	No
Silje Marie Smitt	NTNU	Norway	08 2017 - 08 2021	F	Design and Control of Energy Efficient, Integrated Vapor Compression Units for HVAC and Sanitary Hot Water Systems in high performance Building	No
Marcel Ulrich Ahrens	NTNU Energy	Germany	10 2018 - 09 2022	M	Development of a combined absorption compression heat pump test facility at high temp operation	No
Stefanie Blust	NTNU	Germany	02 2019 - 01 2023	F	Large Hadron Collider (LHC) detector cooling with R744 refrigeration technology	No
Zawadi Mdoe	NTNU	Tanzania	09 2019 - 08 2023	M	Optimal Control of Energy Efficient Industrial Processes under Uncertainty	No

## Master

### Master degrees

Name	Sex	Topic (title)
Avinash Subramanian	M	Reducing Energy Consumption in the production of Hydrogen from Natural Gas
Roxane Giametta	F	Integration of LNG Regasification and Air Separation Units
Morten Dahle Selfors	M	HighEFF partners' expectations for innovation
Jakub Bodys	M	Design and simulations of Refrigerated Sea Water Chillers with CO <sub>2</sub> ejector pumps for marine applications in hot climates
Kun Wan	M	Surrogate model development for an Ammonia synthesis process
Monika Nikolaisen	F	Evaluation of Rankine cycles with mixed component working fluids

Name	Sex	Topic (title)
Alessandro Francesco Castelli	M	Optimization of ORCs for low grade heat recovery: working fluid selection, methodology and applications
Mathias Grønberg Gustum	M	Modelling of gas-solid reactions: Usage of industrial off-gas for pre-reduction of manganese ores
Goran Durakovic	M	Effect of design specifications for off-design operation of low temperature Rankine cycles using zeotropic mixtures and pure working fluids
Inés Encabo Cáceres	F	Techno-economic and thermodynamic optimization of Rankine cycles
Jacopo Degl'Innocenti	M	Compressed air energy storage for clean offshore energy supply
Marius Reed	M	Nonsmooth modelling of multiphase multicomponent heat exchangers with phase changes
Oliver Sale Haugberg	M	Model predictive control of an LNG liquefaction process using Jmodelica.org
Francisco Javier T Garzón	M	Improvement of energy efficiency in a brewery
Espen Halvorsen Verpe	M	Low temperature plate freezing of fish on boats using R744 as refrigerant and cold thermal energy storage
Simon Birger B Solberg	M	Energy-Efficient Designs of Systems – From Nature to Chemical Engineering
Håkon Helland	M	Modeling and Optimization of an Organic Rankine Cycle
Eskild Aas	M	Optimization of Heat Exchanger Networks using Aspen Energy Analyser and SeqHENS
Martin Grimstad	M	Using surplus heat to pre-heat carbon anodes for aluminium electrolysis
Simon Lingaas	M	Energy recovery from batchwise metal casting
Ida Andersskog	F	Plantwide control of thermal power plants
Zawadi Mdoe	M	Optimal control of thermal energy storage under supply and demand uncertainty
Eirik Starheim Svendsen	M	Energy flow analysis of a poultry process plant
Hamza Bajja	M	
Hendrik Poetting	M	Optimization of Energy Systems for Polygeneration Plants
Changhun Jeong	M	Dynamic use of Energy Storage
Andreas S Bunæs	M	Synthesis of Heat Exchanger Networks using SeqHENS
Sandeep Prakash	M	Optimal operation of Thermal Energy Storage
Johannes Doll	M	Evaluation of Ejector supported Supermarket Refrigeration Systems
Patrick Koschel	M	Experimental Investigation of "Waterloop" Refrigeration Systems for Supermarkets
Marie Roux	F	Experimental Study of evaporating Hydrocarbon Flow Characteristics in different small sized Test Tubes
Luca Contiero	M	Experimental Analysis of advanced R744 Refrigeration System
Merethe Selnes	F	Experimental Analysis of an advanced R744 Multi-Ejector
Hesam Pourfallah	M	Dynamic models for combined mass- and energy exchange
Kjetil-Andre Sponland	M	Heat balances and -usage in anode baking furnaces



# Statement of accounts

Costs (1000 NOK)	Amount	Funding (1000 NOK)	Amount
Host institution (SINTEF Energi)	20 026	Research Council of Norway	35 400
Research partners	31 001	Host institution (SINTEF Energi)	3 750
User partners	4 563	Research partners	9 377
Equipment		User partners	13 313
<b>Total</b>	<b>55 590</b>	<b>Total *)</b>	<b>61 840</b>

\*) The extra funding (kNOK 6 250) from the Research Council balances the missing funding from previous years

# Publications 2016-2020

## Peer reviewed journal publications

- Cavalcanti, Suzane M.; Barton, Paul I.**  
Multiple Steady States and Nonsmooth Bifurcations in Dry and Vaporless Distillation Columns. *Industrial & Engineering Chemistry Research* 2020 ;Volume 59. p. 18000-18018
- Grimstad, Martin; Elstad, Kim Ronny; Solheim, Asbjørn; Einarsrud, Kristian Etienne.**  
Utilization of waste heat for pre-heating of anodes. *The Minerals, Metals & Materials Series* 2020 p. 811-816. NTNU SINTEF
- Kauko, Hanne; Rohde, Daniel; Knudsen, Brage Rugstad; Sund-Olsen, Terje.**  
Potential of Thermal Energy Storage for a District Heating System Utilizing Industrial Waste Heat. *Energies* 2020 ;Volume 13.(15) ENERGISINT
- Kazi, Saif R.; Short, Michael; Biegler, Lorenz T.**  
Heat exchanger network synthesis with detailed exchanger designs: Part 1. A discretized differential algebraic equation model for shell and tube heat exchanger design. *AIChE Journal* 2020
- Kazi, Saif R.; Short, Michael; Isafiade, Adeniyi J.; Biegler, Lorenz T.**  
Heat exchanger network synthesis with detailed exchanger designs - 2. Hybrid optimization strategy for synthesis of heat exchanger networks. *AIChE Journal* 2020
- Kingston, Diego; Wilhelmsen, Øivind; Kjelstrup, Signe.**  
Minimum entropy production in a distillation column for air separation described by a continuous non-equilibrium model. *Chemical Engineering Science (CES)* 2020 ;Volume 218. ENERGISINT NTNU
- Kingston, Diego; Wilhelmsen, Øivind; Kjelstrup, Signe.**  
The influence of interfacial transfer and film coupling in the modeling of distillation columns to separate nitrogen and oxygen mixtures. *Chemical Engineering Science: X* 2020 ;Volume 8. p. - ENERGISINT NTNU
- Larsen, Trine Askund; Senk, Dieter Georg; Tangstad, Merete.**  
Reduction of Manganese Ores in CO-CO<sub>2</sub>. Atmospheres. *Metallurgical and Materials Transactions B* 2020. NTNU
- Liu, Kai; Kazi, Saif R.; Biegler, Lorenz T.; Zhang, Bingjian; Chen, Qinglin.**  
Dynamic Optimization for Gas Blending in Pipeline Networks with Gas Interchangeability Control. *AIChE Journal* 2020 ;Volume 66.(5)
- Liu, Zhongxuan; Kim, Donghoi; Gundersen, Truls.**  
Multi-component Fluid Cycles in Liquid Air Energy Storage. *Chemical Engineering Transactions* 2020 ;Volume 81. p. 55-60. NTNU
- Liu, Zhongxuan; Yu, Haoshui; Gundersen, Truls.**  
Optimization of Liquid Air Energy Storage (LAES) using a Genetic Algorithm (GA). *Computer-aided chemical engineering* 2020 ;Volume 48. p. 967-972. NTNU
- Nikolaisen, Monika; Andresen, Trond.**  
System impact of heat exchanger pressure loss in ORCs for smelter off-gas waste heat recovery. *Energy* 2020 ;Volume 215.(B) ENERGISINT
- Pilarczyk, Marcin; Węglowski, Bohdan; Nord, Lars Olof.**  
A Comprehensive Thermal and Structural Transient Analysis of a Boiler's Steam Outlet Header by Means of a Dedicated Algorithm and FEM Simulation. *Energies* 2020 ;Volume 13.(1) p. - NTNU
- Reyes-Lúa, Adriana; Skogestad, Sigurd.**  
Active Constraint Switching with the Generalized Split Range Control Structure using the Baton Strategy. *IFAC-PapersOnLine* 2020. NTNU
- Reyes-Lúa, Adriana; Skogestad, Sigurd.**  
Multi-input single-output control for extending the operating range: Generalized split range control using the baton strategy. *Journal of Process Control* 2020 ;Volume 91. p. 1-11. NTNU
- Ringstad, Knut Emil; Allouche, Yosr; Gullo, Paride; Ervik, Åsmund; Banasiak, Krzysztof; Hafner, Armin.**  
A detailed review on CO<sub>2</sub> two-phase ejector flow modeling. *Thermal Science and Engineering Progress* 2020 ;Volume 20. ENERGISINT NTNU
- Solberg, Simon Birger Byremo; Kjelstrup, Signe; Magnanelli, Elisa; Kizilova, Nataliya; Barroso, Iratxe Lorea Casado; Acquarone, Mario; Folkow, Lars.**  
Energy efficiency of respiration in mature and newborn reindeer. *Journal of Comparative Physiology. B, Biochemical, Systemic, and Environmental Physiology* 2020 ;Volume 190. p. 509-520 ENERGISINT NTNU UiT
- Yamasaki, Haruhiko; Yamaguchi, Hiroshi; Kizilkan, Önder; Kamimura, Takeshi; Hattori, Kazuhiro; Nekså, Petter.**  
Experimental investigation of the effect of solid-gas two-phase flow in CO<sub>2</sub> cascade refrigeration system. *Energy Sources, Part A: Recovery, Utilization, and Environmental Effects* 2020 ENERGISINT
- Yu, Haoshui; Fu, Chao; Gundersen, Truls.**  
Work Exchange Networks (WENs) and Work and Heat Exchange Networks (WHENs): A review of the current state of the art. *Industrial & Engineering Chemistry Research* 2020 ;Volume 59.(2) p. 507-525. ENERGISINT NTNU
- Zhu, Jingwei; Elbel, Stefan W.**  
CFD Simulation of Vortex Flashing R134a Flow expanded

through Convergent-Divergent Nozzles. *International Journal of refrigeration* 2020 ;Volume 112. p. 56-68

21. **Zhu, Jingwei; Elbel, Stefan W.**  
Experimental Investigation into the Influence of Vortex Control on Transcritical R744 Ejector and Cycle Performance. *Applied Thermal Engineering* 2020 ;Volume 164.
22. **Zotica, Cristina; Alsop, Nicholas; Skogestad, Sigurd.**  
Transformed Manipulated Variables for Linearization, Decoupling and Perfect Disturbance Rejection. *IFAC-PapersOnLine* 2020. NTNU
23. **Zotica, Cristina; Nord, Lars O.; Kovács, Jenő; Skogestad, Sigurd.**  
Optimal operation and control of heat to power cycles: A new perspective from a systematic plantwide control approach. *Computers and Chemical Engineering* 2020 ;Volume 141. p. - NTNU
24. **Zotica, Cristina; Pineiro, David Perez; Skogestad, Sigurd.**  
Optimal Operation and Control of a Thermal Energy Storage System: Classical Advanced Control versus Model Predictive Control. *Computer-aided chemical engineering* 2020 ;Volume 48. p. 1507-1512. NTNU

## Presentations

1. **Ahrens, Marcel Ulrich.**  
Utilization of combined absorption-compression heat pumps in industrial high temperature applications. HighEFF Cross-sector Workshop 21 - 22 October 2020; 2020-10-21 - 2020-10-22 NTNU
2. **Allymehr, Ehsan.**  
Effect of internally enhanced surfaces on evaporation of hydrocarbons. HighEFF Cross-sector Workshop 21 - 22 October 2020; 2020-10-21 - 2020-10-22 NTNU
3. **Allymehr, Ehsan.**  
WP2.3 Effective Methods For Hydrocarbon Heat Exchange. HighEFF Cross-sector Workshop 21 - 22 October 2020; 2020-10-21 - 2020-10-22. NTNU
4. **Andersen, Vegar.**  
Flue gas recirculation for the silicon process. HighEFF Cross-sector Workshop 21 - 22 October 2020; 2020-10-21 - 2020-10-22. NTNU
5. **Andersen, Vegar.**  
Increased utilisation of energy contained in the off-gas of the Si submerged arc furnace (SAF) process by gas re-circulation. HighEFF Annual Consortium Meeting 2020; 2020-05-13 - 2020-05-13. NTNU
6. **Andresen, Trond.**  
Heat recovery with thermal energy storage in casting processes. HighEFF Workshop on Thermal Energy Storage; 2020-10-20 - 2020-10-20. ENERGISINT
7. **Andresen, Trond.**  
Heat-to-power conversion in HighEFF. HighEFF - Tekna visit; 2020-01-14. ENERGISINT
8. **Andresen, Trond.**  
RA3 Introduction. HighEFF Cross-sector Workshop 21 - 22 October 2020; 2020-10-21 - 2020-10-22. ENERGISINT
9. **Andresen, Trond.**  
WP3.1 Overview recent H2P activities and Annual Work Plans. HighEFF Cross-sector Workshop 21 - 22 October 2020; 2020-10-21 - 2020-10-22. ENERGISINT
10. **Andresen, Trond; Rohde, Daniel; Skjervold, Vidar T.; Hagen, Brede.**  
Presentations of HighEFF-papers to the Rankine 2020 conference. IIR Rankine Conference 2020 - Advances in Cooling, Heating and Power Generation; 2020-07-27 - 2020-07-31. ENERGISINT
11. **Andresen, Trond; S. Azar, Amin; Hovig, Even Wilberg; Ma, Xiang.**  
Additiv tilvirkning av varmevekslere. HighEFF - site visit Forskningsrådet; 2020-06-08. SINTEF ENERGISINT NTNU
12. **Andresen, Trond; Skjervold, Vidar T.**  
Additive manufacturing as a tool for "Energy Recovery" technology development in HighEFF?. Additive manufacturing as a tool for energy recovery technology development in HighEFF?; 2020-12-03 - 2020-12-03. ENERGISINT
13. **Andresen, Trond; Skjervold, Vidar T.**  
Energy Recovery aspects in aluminium electrolysis off gas recirculation. HighEFF - Off-gas recirculation workshop; 2020-05-12. ENERGISINT
14. **Andresen, Trond; Skjervold, Vidar T.**  
Parameter study on potential for casting energy recovery. NEC-cast - Neste generasjons støpeprosess; 2020-09-30. ENERGISINT
15. **Bantle, Michael.**  
WP 3.2 New IEA Annex HTHP and Annual Work Plans. HighEFF Cross-sector Workshop 21 - 22 October 2020; 2020-10-21 - 2020-10-22. ENERGISINT
16. **Beck, Anton; Røkke, Petter Egil.**  
NEC CETES. HighEFF Cross-sector Workshop 21 - 22 October 2020; 2020-10-21 - 2020-10-22. ENERGISINT
17. **Beck, Anton.**  
Choosing the correct TES technology for steam supply systems. HighEFF Workshop on Thermal Energy Storage; 2020-10-20 - 2020-10-20



18. **Berglihn, Olaf Trygve.**  
Investigating the potential for increased energy utilisation and reduced CO2 emissions at Mo Industripark. HighEFF Annual Consortium Meeting 2020; 2020-05-13 - 2020-05-13. SINTEF
19. **Berglihn, Olaf Trygve.**  
Status and plans WP1.1: KPI's, energy & exergy analyses. HighEFF Cross-sector Workshop 21 - 22 October 2020; 2020-10-21 - 2020-10-22. SINTEF
20. **Blom, Christian.**  
Molten salt thermal energy storage. HighEFF Workshop on Thermal Energy Storage; 2020-10-20 - 2020-10-20
21. **de Boer, Robert.**  
European impact; White paper on High Temperature Heat Pumps. HighEFF Cross-sector Workshop 21 - 22 October 2020; 2020-10-21 - 2020-10-22
22. **Fougner, Hans Simen.**  
Industry impact; Industrial Heat pump as technology contributing to realisation of Hydros targets. HighEFF Cross-sector Workshop 21 - 22 October 2020; 2020-10-21 - 2020-10-22
23. **Fyhn, Håkon.**  
Formation of industrial clusters and challenges to circular energy concepts. HighEFF Cross-sector Workshop 21 - 22 October 2020; 2020-10-21 - 2020-10-22. NTNU
24. **Gabriell, Cecilia H.**  
Heat pump concepts for steam production at Glencore Nikkelverk. HighEFF Annual Consortium Meeting 2020; 2020-05-13 - 2020-05-13. ENERGISINT
25. **Greiner, Christopher Johan.**  
Decarbonization of industrial process steam systems with thermal batteries. HighEFF Workshop on Thermal Energy Storage; 2020-10-20 - 2020-10-20
26. **Gundersen, Truls.**  
Education program in HighEFF – overview of PhDs, Post.docs, publications and industrial short courses. HighEFF Annual Consortium Meeting 2020; 2020-05-13 - 2020-05-13. NTNU
27. **Hafner, Armin.**  
RA2 Introduction. HighEFF Cross-sector Workshop 21 - 22 October 2020; 2020-10-21 - 2020-10-22. NTNU
28. **Hagen, Brede.**  
A mean-line model for performance prediction of Radial Inflow Turbines. HighEFF Cross-sector Workshop 21 - 22 October 2020; 2020-10-21 - 2020-10-22. NTNU
29. **Horntvedt, Bjarne R.**  
New TINE factory in Bergen: integration of six thermal energy storage tanks with a high-temperature hybrid heat pump. HighEFF Workshop on Thermal Energy Storage; 2020-10-20 - 2020-10-20
30. **Isaeva, Irina Nikolayevna.**  
How firms use coordination activities in university-industry collaboration: adjusting to or steering research centre goals. HighEFF Annual Consortium Meeting 2020; 2020-05-13 - 2020-05-13. NORD
31. **Jokiel, Michael.**  
Integration of distributed LT-TES in refrigerated display cabinet. HighEFF Workshop on Thermal Energy Storage; 2020-10-20 - 2020-10-20. ENERGISINT
32. **Kauko, Hanne.**  
Introduction: Research in HighEFF on high-temperature TES. HighEFF Workshop on Thermal Energy Storage; 2020-10-20 - 2020-10-20. ENERGISINT
33. **Kero, Ida.**  
Casting of silicon-rich metals with a super-heated steam atmosphere. HighEFF Annual Consortium Meeting 2020; 2020-05-13 - 2020-05-13. SINTEF
34. **Kero, Ida; Nikolaisen, Monika.**  
Metals & Materials - Plans. HighEFF Cross-sector Workshop 21 - 22 October 2020; 2020-10-21 - 2020-10-22. SINTEF ENERGISINT
35. **Knudsen, Brage Rugstad.**  
Industry Clusters - Highlights from summer student and plans. HighEFF Cross-sector Workshop 21 - 22 October 2020; 2020-10-21 - 2020-10-22. ENERGISINT
36. **Larssen, Trine Asklund.**  
PhD-talk. HighEFF Cross-sector Workshop 21 - 22 October 2020; 2020-10-21 - 2020-10-22. NTNU
37. **Larssen, Trine Asklund.**  
Prereduction of Comilog- and Nchwaning-ore. SFI Metal Production Webinar series; 2020-10-09 - 2020-10-09. SINTEF NTNU
38. **Lindheim, Catharina.**  
Shared resources – the process towards collaboration. HighEFF Annual Consortium Meeting 2020; 2020-05-13 - 2020-05-13 SAMFORSK
39. **Liu, Zhongxuan.**  
Optimization and Economic Evaluation of liquid air energy storage. HighEFF Cross-sector Workshop 21 - 22 October 2020; 2020-10-21 - 2020-10-22. NTNU
40. **Løvland, Martin.**  
Use of Parat high voltage electrode boilers in power to heat

- thermal storages. HighEFF Workshop on Thermal Energy Storage; 2020-10-20 - 2020-10-20
41. **Lånke, Arne Fredrik.**  
The role of cold TES in a more sustainable food industry – based on the case of a new poultry plant at Orkanger. HighEFF Workshop on Thermal Energy Storage; 2020-10-20 - 2020-10-20
  42. **Mdoe, Zawadi Ntengua.**  
Adaptive horizon multistage nonlinear model predictive control. HighEFF Cross-sector Workshop 21 - 22 October 2020; 2020-10-21 - 2020-10-22. NTNU
  43. **Nekså, Petter; Andresen, Trond.**  
FME HighEFF – Anlegg for utnyttelse av overskuddsvarme til kraftproduksjon. Norsk Kjøleteknisk Møte 2020; 2020-10-29 - 2020-10-29. ENERGISINT
  44. **Nikolaisen, Monika; Sæther, Sturla.**  
Oil, Gas & Energy - Highlights from three cases and plans. HighEFF Cross-sector Workshop 21 - 22 October 2020; 2020-10-21 - 2020-10-22. ENERGISINT
  45. **Nikolaisen, Monika.**  
RA6 Introduction. HighEFF Cross-sector Workshop 21 - 22 October 2020; 2020-10-21 - 2020-10-22. ENERGISINT
  46. **Nikolaisen, Monika; Nekså, Petter.**  
Measuring achievement of the HighEFF overall goals. HighEFF Annual Consortium Meeting 2020; 2020-05-13 - 2020-05-13. ENERGISINT
  47. **Nordtvedt, Tom Ståle; Widell, Kristina Norne.**  
Refrigeration and sustainability in the seafood cold chain. 6th IIR conference on sustainability and the cold chain; 2020-08-26 - 2020-08-28. OCEAN
  48. **Pérez-Piñero, David.**  
Optimal operation of thermal energy storage systems under uncertainty. HighEFF Workshop on Thermal Energy Storage; 2020-10-20 - 2020-10-20. NTNU
  49. **Pérez-Piñero, David.**  
Control policies for operating energy storage systems under uncertainty. HighEFF Cross-sector Workshop 21 - 22 October 2020; 2020-10-21 - 2020-10-22. NTNU
  50. **Pilarczyk, Marcin; Nord, Lars O.**  
Conjugate heat transfer analysis in steam generator's plane and internally rifled tube with annular fins. FME HighEFF Cross-sector workshop; 2020-10-21 - 2020-10-22. NTNU
  51. **Ringstad, Knut Emil.**  
CFD for dummies. HighEFF Annual Consortium Meeting 2020; 2020-05-13 - 2020-05-13. NTNU
  52. **Ringstad, Knut Emil.**  
Machine learning for design and performance mapping of R744 ejectors. HighEFF Cross-sector Workshop 21 - 22 October 2020; 2020-10-21 - 2020-10-22. NTNU
  53. **Rohde, Daniel.**  
Elkem Thamshavn's energy recovery system – Analysis of control strategies and thermal storage potential. HighEFF Annual Consortium Meeting 2020; 2020-05-13 - 2020-05-13. ENERGISINT
  54. **Røkke, Petter Egil.**  
Information from centre management & concluding remarks. HighEFF Cross-sector Workshop 21 - 22 October 2020; 2020-10-21 - 2020-10-22. ENERGISINT
  55. **Røkke, Petter Egil.**  
Introduction - HighEFF Annual Consortium Meeting 2020. HighEFF Annual Consortium Meeting 2020; 2020-05-13 - 2020-05-13. ENERGISINT
  56. **Røkke, Petter Egil.**  
Welcome to 2020 Cross Sector Workshop. HighEFF Cross-sector Workshop 21 - 22 October 2020; 2020-10-21 - 2020-10-22. ENERGISINT
  57. **S. Azar, Amin.**  
NEC HighEx. HighEFF Cross-sector Workshop 21 - 22 October 2020; 2020-10-21 - 2020-10-22. SINTEF
  58. **Schlemminger, Christian.**  
Work Recovery & Compressors - Real ejector performance in the field. HighEFF Cross-sector Workshop 21 - 22 October 2020; 2020-10-21 - 2020-10-22. ENERGISINT
  59. **Selvnes, Håkon.**  
A cold thermal energy storage unit for CO2 refrigeration systems: Experimental results. HighEFF Cross-sector Workshop 2020; 2020-10-21 - 2020-10-22. NTNU
  60. **Selvnes, Håkon.**  
Experimental results with PCM-based LT-TES using a horizontal pillow plate HX. HighEFF Workshop on Thermal Energy Storage; 2020-10-20 - 2020-10-20. NTNU
  61. **Selvnes, Håkon.**  
Termiske kuldager for CO2 anlegg: Første måleresultater. Norsk Kjøleteknisk Møte 2020; 2020-10-29 - 2020-10-29. NTNU
  62. **Selvnes, Håkon; Büttner, Vera; Hafner, Armin.**  
Evaluation of a pillow-plate heat exchanger for a pump-circulated CO2 refrigeration system. 14th IIR Gustav Lorentzen Conference on Natural Refrigerants; 2020-12-07 - 2020-12-09. NTNU
  63. **Sevault, Alexis.**  
Integration of a 200-kWh PCM-based heat storage at the ZEB

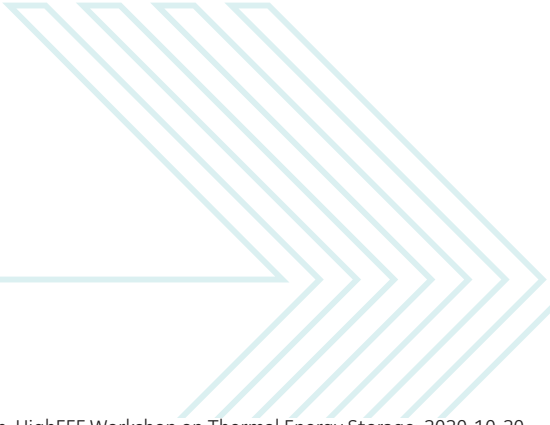

Lab. HighEFF Workshop on Thermal Energy Storage; 2020-10-20 - 2020-10-20. ENERGISINT

64. **Sevault, Alexis.**

Introduction: What can LT/MT thermal energy storage do for you?. HighEFF Workshop on Thermal Energy Storage; 2020-10-20 - 2020-10-20. ENERGISINT

65. **Sevault, Alexis.**

KPN PCM-STORE – PCM-based low-temperature energy storage for a more sustainable food industry. HighEFF Workshop on Thermal Energy Storage; 2020-10-20 - 2020-10-20. ENERGISINT

66. **Sevault, Alexis; Kauko, Hanne.**

HighEFF & PCM-STORE Workshop on Thermal Energy Storage. HighEFF & PCM-STORE Workshop on Thermal Energy Storage; 2020-10-20 - 2020-10-20. ENERGISINT

67. **Skaugen, Geir.**

Modelling of compact plate heat exchanger in a context of process optimisation. HighEFF Annual Consortium Meeting 2020; 2020-05-13 - 2020-05-13. ENERGISINT

68. **Skaugen, Geir.**

WP2.1 Heat Exchangers. HighEFF Cross-sector Workshop 21 - 22 October 2020; 2020-10-21 - 2020-10-22. ENERGISINT

69. **Skjervold, Vidar T.**

NEC NECast. HighEFF Cross-sector Workshop 21 - 22 October 2020; 2020-10-21 - 2020-10-22. ENERGISINT

70. **Skjervold, Vidar T.**

NECast Novel Emerging Concept. HighEFF RA/WP leader meeting; 2020-08-20 - 2020-08-20. ENERGISINT

71. **Skjervold, Vidar T.; Andresen, Trond.**

Introduction and overview of recent and planned activities. Additive manufacturing as a tool for energy recovery technology development in HighEFF?; 2020-12-03 - 2020-12-03. ENERGISINT

72. **Skjervold, Vidar T.; Kero, Ida; Gouttebroze, Sylvain.**

Relevant technology elements for NECast concept. NECast - Neste generasjons støpeprosess; 2020-09-29 - 2020-09-29. ENERGISINT SINTEF

73. **Skybakmoen, Egil.**

RA1 Introduction and overview. HighEFF Cross-sector Workshop 21 - 22 October 2020; 2020-10-21 - 2020-10-22. SINTEF

74. **Smitt, Silje Marie.**

CO<sub>2</sub> heat pump and chiller system for centralized kitchens in India. HighEFF Cross-sector Workshop 21 - 22 October 2020; 2020-10-21 - 2020-10-22. NTNU

75. **Solheim, Asbjørn.**

Pot Gas Handling and Energy Recovery for Future CCS in the AI

Industry. HighEFF Cross-sector Workshop 21 - 22 October 2020; 2020-10-21 - 2020-10-22. SINTEF

76. **Sørhuus, Anders.**

Industry. HighEFF Cross-sector Workshop 21 - 22 October 2020; 2020-10-21 - 2020-10-22

77. **Thombre, Mandar.**

Optimizing the capacity of thermal energy storage in industrial clusters. HighEFF Cross-sector Workshop 21 - 22 October 2020; 2020-10-21 - 2020-10-22. NTNU

78. **Thombre, Mandar.**

Robust control of energy systems – How to effectively handle uncertainty. HighEFF Annual Consortium Meeting 2020; 2020-05-13 - 2020-05-13. NTNU

79. **Verpe, Espen Halvorsen.**

Industrial high temperature heat pumps – available and conceptual technology for supply temperature above 150°C. HighEFF Annual Consortium Meeting 2020; 2020-05-13 - 2020-05-13. ENERGISINT

80. **Vidal, Andre Salles; Fougner, Hans Simen.**

Opportunities for Energy Storage Integration in the Aluminum Industry. HighEFF Workshop on Thermal Energy Storage; 2020-10-20 - 2020-10-20

81. **Vikse, Matias.**

A nonsmooth approach to modelling and optimization – applications to liquefied natural gas processes and work and heat exchange networks. HighEFF Annual Consortium Meeting 2020; 2020-05-13 - 2020-05-13. ENERGISINT

82. **Wærnes, Aud Nina.**

Introduction RA4. HighEFF Cross-sector Workshop 21 - 22 October 2020; 2020-10-21 - 2020-10-22. SINTEF

83. **Zotica, Cristina; Pérez-Piñero, David; Skogestad, Sigurd.**

Optimal Operation and Control of a Thermal Energy Storage System: Classical Advanced Control versus Model Predictive Control. HighEFF Cross-Sector Workshop; 2020-10-21 - 2020-10-22. NTNU

## Peer-reviewed papers

1. **Álvarez Pardiñas, Ángel; Contiero, Luca; Hafner, Armin; Banasiak, Krzysztof; Larsen, Lars F.S.**

Attaining a higher flexibility degree in CO<sub>2</sub> compressor racks.

I: *Proceedings of the 14th IIR-Gustav Lorentzen Conference on Natural Refrigerants*. International Institute of Refrigeration 2020 ISBN 978-2-36215-040-1. p. 512-517. ENERGISINT NTNU

- 
2. **Andresen, Trond; Lingsaas, Simon Johan Nilsen; Hagen, Brede; Nekså, Petter.**  
Dynamic Analysis of Energy Recovery Utilizing Thermal Storage from Batch-Wise Metal Casting. I: *IIR Rankine Conference 2020*. International Institute of Refrigeration 2020 ISBN 978-2-36215-038-8. ENERGISINT NTNU
  3. **Deng, Han; Hagen, Brede; Nikolaisen, Monika; Andresen, Trond.**  
Comparing Three Methods for Design Analyses of Rankine Cycle for Waste Heat Recovery from Natural Gas Compression. I: *IIR Rankine Conference 2020*. International Institute of Refrigeration 2020 ISBN 978-2-36215-038-8. ENERGISINT NTNU
  4. **Gylver, Sindre Engzelius; Solheim, Asbjørn; Gudbrandsen, Henrik; Follo, Åste Heggli; Einarsrud, Kristian Etienne.**  
Lab Scale Experiments on Alumina Raft Formation. I: *Light Metals 2020*. Springer 2020 ISBN 978-3-030-36407-6. p. 659-663  
NTNU SINTEF
  5. **Hagen, Brede; Cavo, Matteo; Andresen, Trond; Nekså, Petter.**  
Gradient Based Design Optimization of a Radial Inflow Turbine. I: *IIR Rankine Conference 2020*. International Institute of Refrigeration 2020 ISBN 978-2-36215-038-8. ENERGISINT NTNU
  6. **Nordtvedt, Tom Ståle; Widell, Kristina Norne.**  
Refrigeration and sustainability in the seafood cold chain. I: *6th IIR Conference on Sustainability and the Cold Chain - Proceedings*. International Institute of Refrigeration 2020 ISBN 978-2-36215-036-4. OCEAN
  7. **Rohde, Daniel; Andresen, Trond; Zotica, Cristina; Wilpert, Paul.**  
Energy Recovery From Furnace Off-Gas: Analysis of an Integrated Energy Recovery System by Means of Dynamic Simulation. I: *IIR Rankine Conference 2020*. International Institute of Refrigeration 2020 ISBN 978-2-36215-038-8. ENERGISINT NTNU
  8. **Schlemminger, Christian; Kopp, Christian Andre; Banasiak, Krzysztof; Drexler-Schmid, Gerwin; Lauermann, Michael; Windholz, Bernd; Zauner, Christoph; Baumhakel, Alexander.**  
Hochtemperatur Wärmepumpe mit Ejektor. I: *45th Annual Meeting of the Deutscher Kaelte und Klimatechnischer Verein 2019: Deutsche Kaelte-und Klimatagung 2019 Ulm*. Curran Associates, Inc. 2020 ISBN 9781713807209. ENERGISINT
  9. **Selvnes, Håkon; Büttner, Vera; Hafner, Armin.**  
Evaluation of a pillow-plate heat exchanger for a pump-circulated CO<sub>2</sub> refrigeration system. I: *Proceedings of the 14th IIR-Gustav Lorentzen Conference on Natural Refrigerants*. International Institute of Refrigeration 2020 ISBN 978-2-36215-040-1. p. 97-102. NTNU
  10. **Shahrooz, Mina; Lundqvist, Per; Nekså, Petter.**  
Effect of Waste Heat Utilization on the Performance of Low Temperature Rankine Cycle. I: *IIR Rankine Conference 2020*. International Institute of Refrigeration 2020 ISBN 978-2-36215-038-8. ENERGISINT NTNU
  11. **Skjervold, Vidar T.; Skaugen, Geir; Andresen, Trond; Nekså, Petter.**  
Enabling Power Production from Challenging Industrial Off-Gas – Model-Based Investigation of a Novel Heat Recovery Concept. I: *IIR Rankine Conference 2020*. International Institute of Refrigeration 2020 ISBN 978-2-36215-038-8. ENERGISINT
  12. **Solheim, Asbjørn; Senanu, Samuel.**  
Recycling of the Flue Gas from Aluminium Electrolysis Cells. I: *Light Metals 2020*. Springer 2020 ISBN 978-3-030-36407-6. p. 803-810. SINTEF
  13. **Thombre, Mandar; Prakash, Sandeep; Knudsen, Brage Rugstad; Jäschke, Johannes.**  
Optimizing the Capacity of Thermal Energy Storage in Industrial Clusters. I: *Proceedings of the 30th European Symposium on Computer Aided Process Engineering*. Elsevier 2020 ISBN 9780128233771. p. 1459-1464. ENERGISINT NTNU
  14. **Tolstorebrov, Ignat; Zendejboudi, Alireza; Banasiak, Krzysztof; Köster, Lukas; Álvarez Pardiñas, Ángel; Hafner, Armin.**  
Testing of tri-partite CO<sub>2</sub> gas cooler prototype for domestic hot water and space heating. I: *Proceedings of the 14th IIR-Gustav Lorentzen Conference on Natural Refrigerants*. International Institute of Refrigeration 2020 ISBN 978-2-36215-040-1. p. 91-96  
ENERGISINT NTNU
  15. **Trædal, Stian; Skaugen, Geir; Nikolaisen, Monika; Stang, Hans Georg Jacob.**  
Experimental heat exchanger test facility for evaporation and condensation of hydrocarbons. I: *Proceedings of the 14th IIR-Gustav Lorentzen Conference on Natural Refrigerants*. International Institute of Refrigeration 2020 ISBN 978-2-36215-040-1. ENERGISINT
  16. **Yamasaki, Haruhiko; Wakimoto, Hiroyuki; Yamaguchi, Hiroshi; Nekså, Petter.**  
Solar heat recovery system using CO<sub>2</sub> as working fluid. I: *Proceedings of the 14th IIR-Gustav Lorentzen Conference on Natural Refrigerants*. International Institute of Refrigeration 2020 ISBN 978-2-36215-040-1. p. 375-380. ENERGISINT NTNU
  17. **Yu, Haoshui; Fu, Chao; Gundersen, Truls; Gencer, Emre.**  
Optimal use of Process Streams as Working Fluids in Work and Heat Exchange Networks (WHENS). I: *Proceedings of the 30th*



*European Symposium on Computer Aided Process Engineering.*  
Elsevier 2020 ISBN 9780128233771. p. 739-744. ENERGISINT  
NTNU

## Report/thesis

1. **Nikolaisen, Monika.**  
Initial economic considerations of proposed heat-to-power system at MIP. TRONDHEIM: SINTEF Energi AS 2020 7 p. ENERGISINT Media Contributions
1. **Claussen, Ingrid Camilla.**  
Banebrytende: Verdens første digitale snøguide lanseres i dag. Norges idrettsforbund [Internet] 2020-09-09. ENERGISINT
2. **Claussen, Ingrid Camilla.**  
Eit kaldt kjøleskap kan gi varmt badevatn. Nysgjerriger [Internet] 2020-11-09. ENERGISINT
3. **Claussen, Ingrid Camilla.** Verdas første digitale snø-guide er lansert. Samnanger kommune [Internet] 2020-09-11. ENERGISINT
4. **Claussen, Ingrid Camilla.**  
Verdens første digitale snø-guide er lansert. Gemini.no [Internet] 2020-09-16. ENERGISINT
5. **Claussen, Ingrid Camilla.**  
Verdens første digitale snø-guide lanseres i dag. Skiskyting.no [Internet] 2020-09-09. ENERGISINT
6. **Kauko, Hanne.**  
– Norske byer kan bli nærmest selvforsynte på varme. VVSFORUM [Business/trade/industry journal] 2020-08-11. ENERGISINT
7. **Nekså, Petter.**  
Bedre HVAC-systemer kan hjelpe hotellnæringen. VVS Aktuelt [Business/trade/industry journal] 2020-06-17. ENERGISINT
8. **Nekså, Petter.**  
Historien om CO2 som kjølemedium. sintef.no [Internet] 2020-06-03. ENERGISINT
9. **Nekså, Petter.**  
Norske hoteller kan redusere strømgning med hele 44 prosent. ITBA Aktuelt [Internet] 2020-06-18. ENERGISINT
10. **Nekså, Petter.**  
Slik kan hotellene halvere strømgning. enerWE [Business/trade/industry journal] 2020-06-17. ENERGISINT
11. **Nekså, Petter.**  
Standard for brannfarlige kuldemedier i varmpumper til avstemning. VVSFORUM [Business/trade/industry journal] 2020-10-21. ENERGISINT
12. **Nekså, Petter.**  
Standard for brannfarlige kuldemedier i varmpumper til avstemning. VVS aktuelt [Business/trade/industry journal] 2020-10-21. NTNU
13. **Nekså, Petter.**  
The story of CO2 as a refrigerant. sintef.no [Internet] 2020-04-20. ENERGISINT
14. **Røkke, Nils Anders.**  
– En etterlengtet og gledelig milepæl. sintef.no [Internet] 2020-09-22. ENERGISINT
15. **Røkke, Nils Anders.**  
Derfor fortjener kloden et norsk ja til CO2-håndtering. sintef.no [Internet] 2020-03-11. ENERGISINT
16. **Røkke, Petter Egil.**  
Bedre HVAC-systemer kan hjelpe hotellnæringen. VVS aktuelt [Business/trade/industry journal] 2020-06-17. ENERGISINT
17. **Røkke, Petter Egil.**  
Making Norwegian industry the world's greenest - HighEFF's Past, Present and Future. sintef.no [Internet] 2020-04-16. ENERGISINT
18. **Røkke, Petter Egil.**  
Norske hoteller kan redusere strømgning med hele 44 prosent. ITBAKTUELT [Internet] 2020-06-18. ENERGISINT
19. **Røkke, Petter Egil.**  
Slik kan hotellene halvere strømgning. enerWE [Business/trade/industry journal] 2020-06-17. ENERGISINT
20. **Røkke, Petter Egil.**  
Slik kan hotellene kutte strømgning med nesten 50 prosent. Radio Nordkapp [Radio] 2020-06-17. ENERGISINT
21. **Røkke, Petter Egil.**  
Slik kan hotellene kutte strømgning med nesten 50 prosent. Horecanytt [Internet] 2020-06-17. ENERGISINT
22. **Røkke, Petter Egil.**  
Slik kan hotellene kutte strømgning med nesten 50 prosent. sintef.no [Internet] 2020-06-17. ENERGISINT

## Featured article/op-ed

1. **Selvnes, Håkon.**  
Mer effektiv kuldslagring. *Kulde og varmpumper* 2020 (3) p. 34-40. NTNU
2. **Selvnes, Håkon.**  
Resultater for kuldslagring. *Kulde og varmpumper* 2020 (6) p. 36-42. NTNU



## Blogs and information material

1. **Anantharaman, Rahul.**  
Work and Heat Exchange Networks: Simultaneous Process Optimisation and Heat Integration. ENERGISINT
2. **Claussen, Ingrid Camilla.**  
Keeping Ice Cream Cold Doesn't Have to Harm the Environment. ENERGISINT
3. **Kauko, Hanne.**  
Dette kan være løsningen på verdens enorme vind- og solproblem. ENERGISINT
4. **Kauko, Hanne.**  
Providing Value to Industry in Just 8 Weeks. ENERGISINT
5. **Nikel, David Matthew.**  
How Hotels Can Slash Their Energy Bills. ENERGISINT
6. **Ringstad, Knut Emil.**  
Numerical Fluid Mechanics: CFD Made Simple. NTNU
7. **Ringstad, Knut Emil.**  
Numerisk fluidmekanikk/CFD enkelt forklart. NTNU
8. **Skjervold, Vidar T.**  
Next-Generation Casting Process for the Ferroalloy Industry. ENERGISINT
9. **Smitt, Silje Marie.**  
"All-in-one" Thermal Solutions for Heating and Cooling in Hotels. NTNU
10. **Smitt, Silje Marie.**  
How Hotels Can Slash Their Energy Bills. NTNU
11. **Vikse, Matias.**  
NEC INTERCUR: Integrated Energy Systems for Industrial Clusters. NTNU. Multimedia products
1. **Andresen, Trond.**  
3D printing av varmevekslere. SINTEF Energi 2020. ENERGISINT
2. **Istad, Maren Kristine.**  
Tour of the Norwegian National Smart Grid Laboratory. SINTEF Energi AS 2020. ENERGISINT
3. **Kauko, Hanne.**  
Fjernvarmedagene | Leangen. SINTEF Energi AS 2020. ENERGISINT
4. **Nekså, Petter.**  
How CO2 Can Help The Climate. SINTEF Energi AS 2020. ENERGISINT
5. **Nekså, Petter.**  
Norsk teknologi kan kutte 0,5 grader global oppvarming!. SINTEF Energi 2020. NTNU
6. **Røkke, Petter Egil.**  
Making industries greener - HighEFF Annual report 2019. SINTEF Energi 2020. ENERGISINT

7. **Smitt, Silje Marie.**

Hoteller kan kutte strømregningen med nesten 50 prosent. SINTEF Energi 2020. NTNU

## Media contributions

1. **Bantle, Michael.**  
Lars Hansens varmepumpe skal være «minst» 35 prosent mer effektiv enn nærmeste konkurrent. Har fått avtale med Panasonic. Polar Energi [Internett] 2019-12-17. ENERGISINT
2. **Bantle, Michael.**  
Sintefs nye varmepumpe kan lage 160 grader varm damp. TU [Fagblad] 2019-01-22. ENERGISINT
3. **Claussen, Ingrid Camilla.**  
Banebrytende: Verdens første digitale snøguide lanseres i dag. Norges idrettsforbund [Internett] 2020-09-09. ENERGISINT
4. **Claussen, Ingrid Camilla.**  
Eit kaldt kjøleskap kan gi varmt badevatn. Nysgjerriger [Internett] 2020-11-09. ENERGISINT
5. **Claussen, Ingrid Camilla.**  
Norske forskere bak iskald miljøteknologi. abcnyheter.no [Fagblad] 2018-08-15. ENERGISINT
6. **Claussen, Ingrid Camilla.** Verdas første digitale snø-guide er lansert. Samnanger kommune [Internett] 2020-09-11. ENERGISINT
7. **Claussen, Ingrid Camilla.**  
Verdens første digitale snø-guide er lansert. Gemini.no [Internett] 2020-09-16. ENERGISINT
8. **Claussen, Ingrid Camilla.**  
Verdens første digitale snø-guide lanseres i dag. Skiskyting.no [Internett] 2020-09-09. ENERGISINT
9. **Claussen, Ingrid Camilla.**  
400-500 millioner til Forsknings-Trondheim. Adresseavisen [Avis] 2017-06-27. ENERGISINT
10. **Claussen, Ingrid Camilla; Eberg, Espen.**  
60 millioner for å gjøre industrien mer klimavennlig. Adresseavisen [Avis] 2017-06-27. ENERGISINT NTNU
11. **Hemmingsen, Anne Karin Torstveit.**  
Green cooling with CO2. Gemini [Fagblad] 2016-10-25. ENERGISINT
12. **Hemmingsen, Anne Karin Torstveit.**  
MIP med i nytt forskningssenter for miljøvennlig energi. Mo Industripark AS [Internett] 2016-05-26. ENERGISINT
13. **Hemmingsen, Anne Karin Torstveit.**  
Norway Unveils World's Largest Center for Research into Industrial Energy Efficiency. World Industrial Reporter [Avis] 2016-12-09. NTNU

14. **Hemmingsen, Anne Karin Torstveit.**  
Vil bli internasjonalt flaggskip. Mo Industripark AS [Internett] 2016-07-15. ENERGISINT
15. **Hemmingsen, Anne Karin Torstveit; Mølsvik, Mona J.; Kjølle, Gerd Hovin.**  
1,3 milliarder til forskning på miljøteknologi. Gemini [Fagblad] 2016-05-26. ENERGISINT
16. **Kauko, Hanne.**  
– Norske byer kan bli nærmest selvforsynte på varme. VVSFORUM [Fagblad] 2020-08-11. ENERGISINT
17. **Kauko, Hanne.** Dette kan være løsningen på verdens enorme vind- og solproblem. Nettavisen.no [Internett] 2019-11-26. ENERGISINT
18. **Kauko, Hanne.**  
Dette kan være løsningen på verdens enorme vind- og solproblem. Nettavisen [Internett] 2019-11-26. ENERGISINT
19. **Kauko, Hanne.**  
District Heating Warms Cities Without Fossil Fuels. ecowatch.com [Fagblad] 2018-01-15. ENERGISINT
20. **Nekså, Petter.**  
Bedre HVAC-systemer kan hjelpe hotellnæringen. VVS Aktuelt [Fagblad] 2020-06-17. ENERGISINT
21. **Nekså, Petter.**  
Historien om CO2 som kjølemedium. sintef.no [Internett] 2020-06-03. ENERGISINT
22. **Nekså, Petter.**  
Norske hoteller kan redusere strømgregningen med hele 44 prosent. ITBA Aktuelt [Internett] 2020-06-18. ENERGISINT
23. **Nekså, Petter.**  
Slik kan hotellene halvere strømgregningen. enerWE [Fagblad] 2020-06-17. ENERGISINT
24. **Nekså, Petter.**  
Standard for brannfarlige kuldemedier i varmepumper til avstemning. VVSFORUM [Fagblad] 2020-10-21. ENERGISINT
25. **Nekså, Petter.**  
Standard for brannfarlige kuldemedier i varmepumper til avstemning. VVS aktuelt [Fagblad] 2020-10-21. NTNU
26. **Nekså, Petter.**  
The story of CO2 as a refrigerant. sintef.no [Internett] 2020-04-20. ENERGISINT
27. **Nekså, Petter.**  
VM-stadionet forurenser like mye hver dag som å kjøre bil 20 ganger rundt ekvator. NRK [Internett] 2019-10-04. ENERGISINT
28. **Nekså, Petter; Hemmingsen, Anne Karin Torstveit.**  
– La naturens egne stoffer overta som kjølegasser. ITBAktuelt [Internett] 2016-10-28. ENERGISINT
29. **Nekså, Petter; Hemmingsen, Anne Karin Torstveit.**  
CO2 gir grønn kjøling. GEMINI [Fagblad] 2016-10-21. ENERGISINT
30. **Røkke, Nils Anders.**  
– En etterlengtet og gledelig milepæl. sintef.no [Internett] 2020-09-22. ENERGISINT
31. **Røkke, Nils Anders.**  
Derfor fortjener kloden et norsk ja til CO2-håndtering. sintef.no [Internett] 2020-03-11. ENERGISINT
32. **Røkke, Petter Egil.**  
Bedre HVAC-systemer kan hjelpe hotellnæringen. VVS aktuelt [Fagblad] 2020-06-17. ENERGISINT
33. **Røkke, Petter Egil.**  
Fra blomstereng i hagen til løsninger for en bedre verden. NOBIO [Internett] 2019-08-16. ENERGISINT
34. **Røkke, Petter Egil.**  
Making Norwegian industry the world's greenest - HighEFF's Past, Present and Future. sintef.no [Internett] 2020-04-16. ENERGISINT
35. **Røkke, Petter Egil.**  
Norske hoteller kan redusere strømgregningen med hele 44 prosent. ITBAKTUELT [Internett] 2020-06-18. ENERGISINT
36. **Røkke, Petter Egil.**  
Slik kan hotellene halvere strømgregningen. enerWE [Fagblad] 2020-06-17. ENERGISINT
37. **Røkke, Petter Egil.**  
Slik kan hotellene kutte strømgregningen med nesten 50 prosent. Radio Nordkapp [Radio] 2020-06-17. ENERGISINT
38. **Røkke, Petter Egil.**  
Slik kan hotellene kutte strømgregningen med nesten 50 prosent. Horecanytt [Internett] 2020-06-17. ENERGISINT
39. **Røkke, Petter Egil.**  
Slik kan hotellene kutte strømgregningen med nesten 50 prosent. sintef.no [Internett] 2020-06-17. ENERGISINT
40. **Sevault, Alexis.**  
Har du hørt om faseendingsmaterialer?. Kulde og varmepumper 2018 ;Volum 5. s. 12-14. ENERGISINT
41. **Sevault, Alexis.**  
Har du hørt om faseendingsmaterialer?. Gemini 2018. ENERGISINT
42. **Sevault, Alexis.**  
Har du hørt om faseendingsmaterialer?.. Har du hørt om faseendingsmaterialer?. [Fagblad] 2018-09-05. ENERGISINT



**HighEFF – Centre for an Energy Efficient  
and Competitive Industry for the Future**

HighEFF is a Centre for Environment-friendly Energy Research (FME).  
The objective of the FME-scheme is to establish time- limited research  
centres which conduct concentrated, focused and long-term  
research of high international calibre.

**Contacts:**

Centre Manager Petter E. Røkke - [Petter.E.Rokke@sintef.no](mailto:Petter.E.Rokke@sintef.no)

Centre Coordinator Ragnhild Sæterli - [ragnhild.saterli@sintef.no](mailto:ragnhild.saterli@sintef.no)

and Line Rydså - [Line.Rydsa@sintef.no](mailto:Line.Rydsa@sintef.no)