

PLUG
Power Generation during Loading & Unloading
concept for
LNGCs
...and others

Presentation to SIGTTO meeting, Paris, 26-09-07

Your contact : Damien.feger@sneema.fr



■ The up coming “Cold ironing” requirements

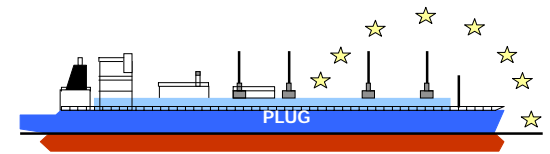

- ▶ To answer to environmental pressure on emissions
- ▶ 8 MW / 6600 V capability to cover hotel + cargo pump loads
- ▶ Compatible with LNG carriers and terminals operational and safety requirements



« Cold ironing » state of the art

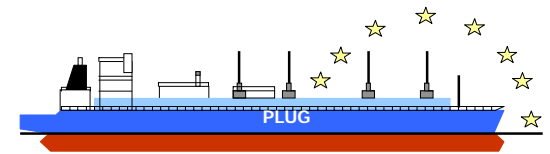

Cold ironing power interface are already proposed or operational for cruise vessels and container carriers

In most cases, they do not meet LNGC safety requirements...



Understanding the cold ironing requirement

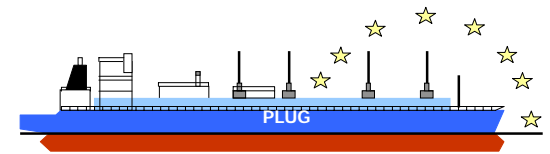

- ▶ In most cases, cold ironing is more expensive and troublesome than on board generation

- ▶ But it is upcoming in order to :
 - Reduce global emissions
 - Reduce local harbour emissions (especially in case of a peak of pollution)
.....without stopping (un)loading operations

■ Cold ironing emission performance

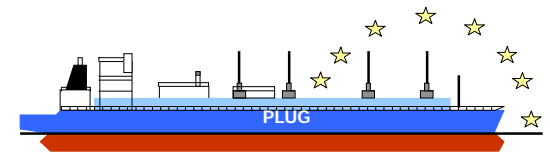

- ▶ Cold ironing emission performance and strategy may differ depending on :
 - Vessel emission performance
 - Local power network emissions performances and grid capability

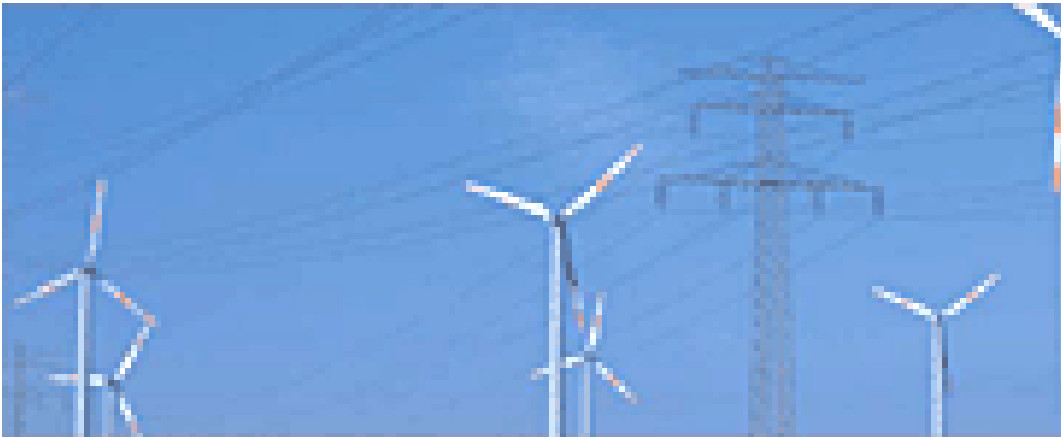

Ultimate environmental performance will depend on the global performance of the vessel / grid / power sources!!!

Matching The RES (wind power) challenge

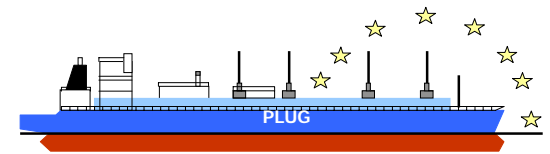

- ▶ The growth of RES in the energy mix is a major challenge for power network and requires massive investment to match supply and demand :
 - Re enforced power line network to avoid grid congestion
 - Increased “reserve” Power

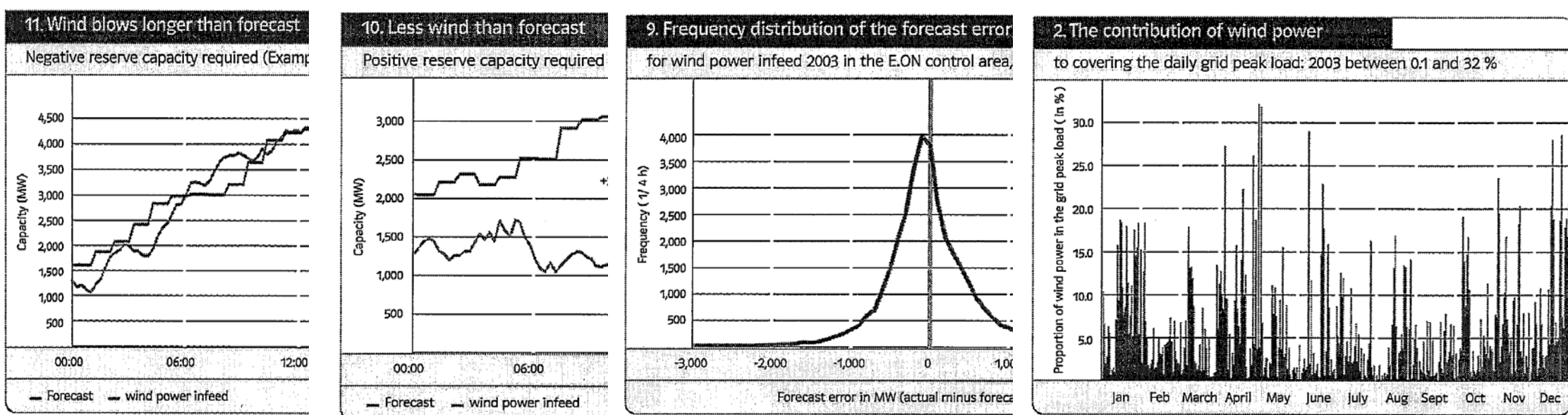

Extract from E.on wind power report

The power generation opportunity

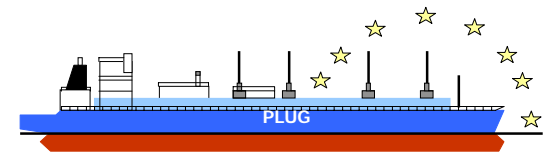

- ▶ It could be very attractive to use electric propulsion vessels in ports to provide « reserve » power capabilities to support RES..

Diesel electric propulsion penetration in cruise business

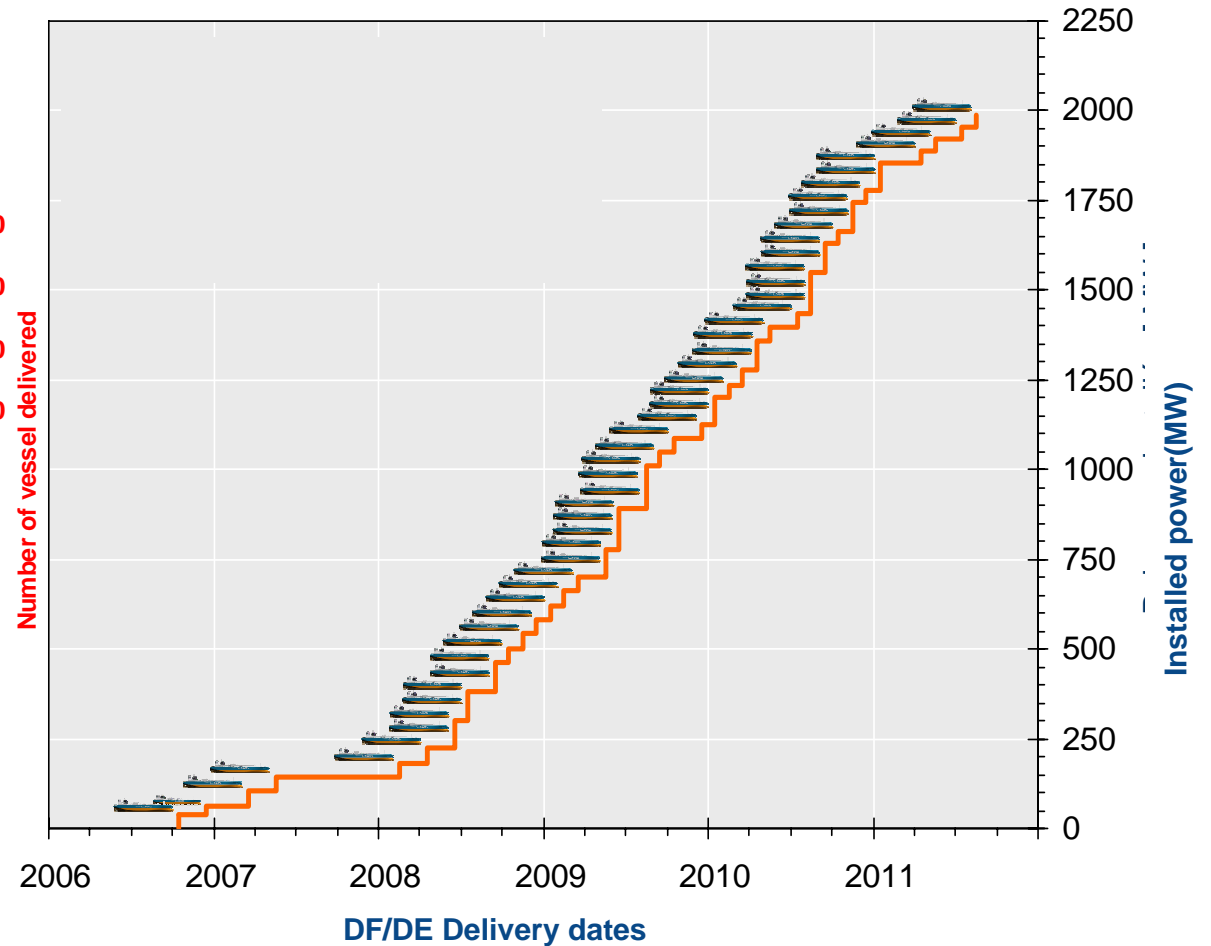
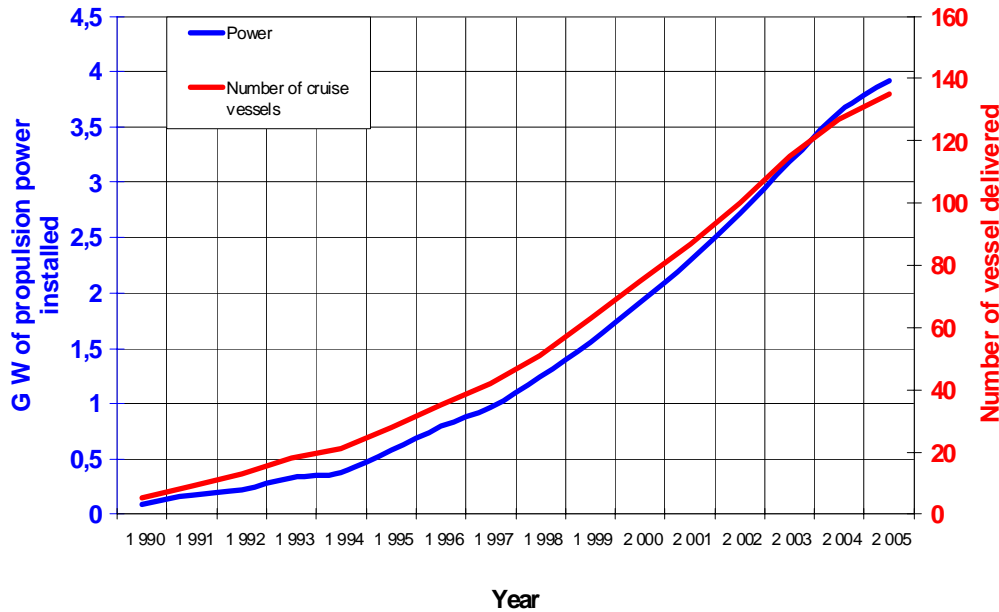

Global emission optimisation

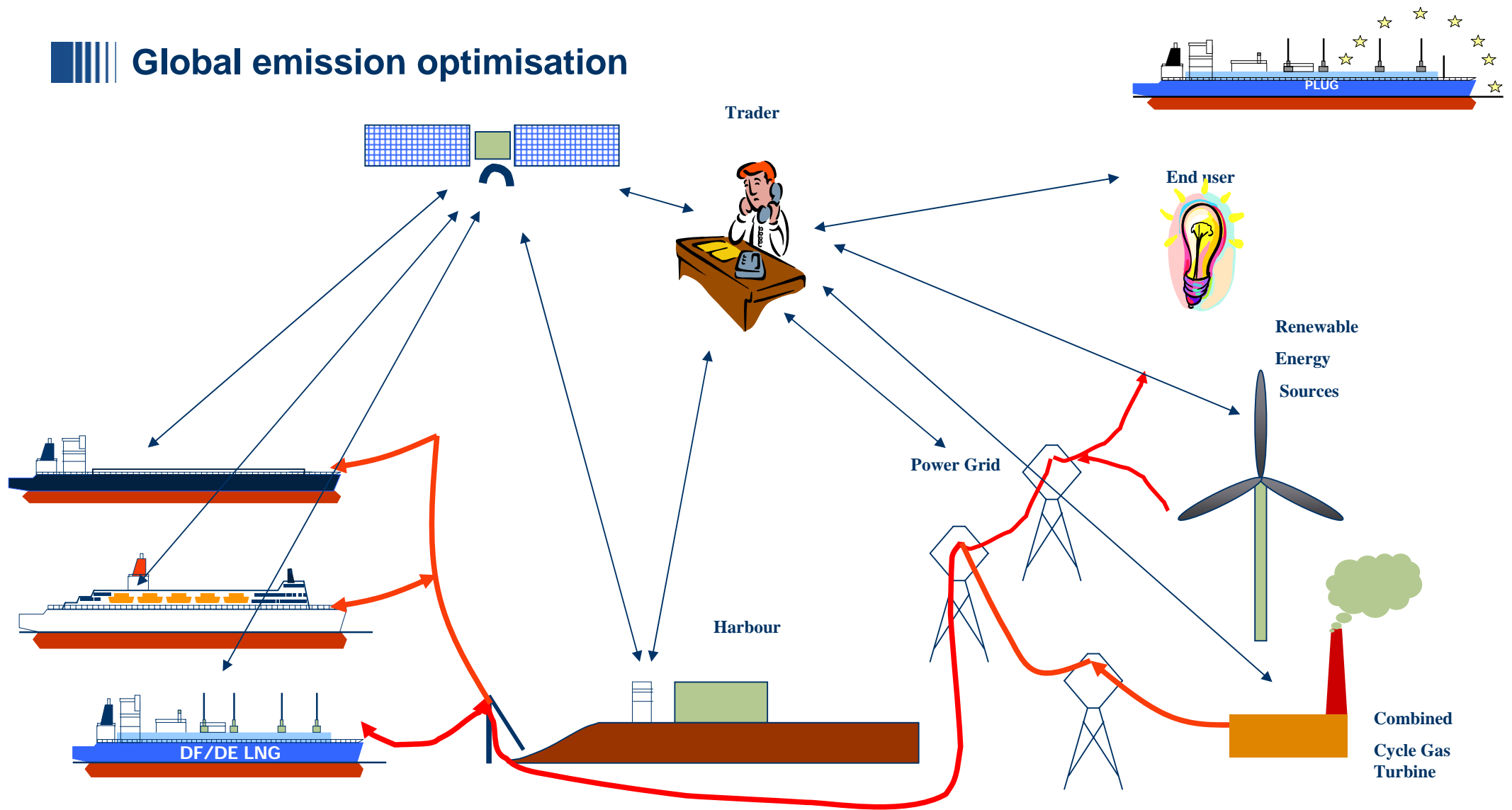

- ▶ Once connected to the shore network, Electric propulsion vessels, such as LNGCs, can be used as back up power source especially in combination with RES...

■ The DF/DE LNGC competitive advantage

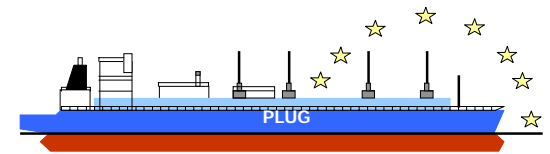

- ▶ DF/DE LNGC power architecture is directly compatible with high voltage power exchange
 - Cold ironing consumption from 2 to 8 MW to absorb excess RES power production
 - Power generation up to 25 MW to support RES power shortage
 - Minimum Capex by using the existing propulsion equipment
 - Minimum Opex *and emissions* by using BOG as fuel
- ▶ Opportunity :
 - Valorise propulsion system investment
 - Valorise terminal and carrier boil off
 - Support RES development by providing low cost reserve capacity...

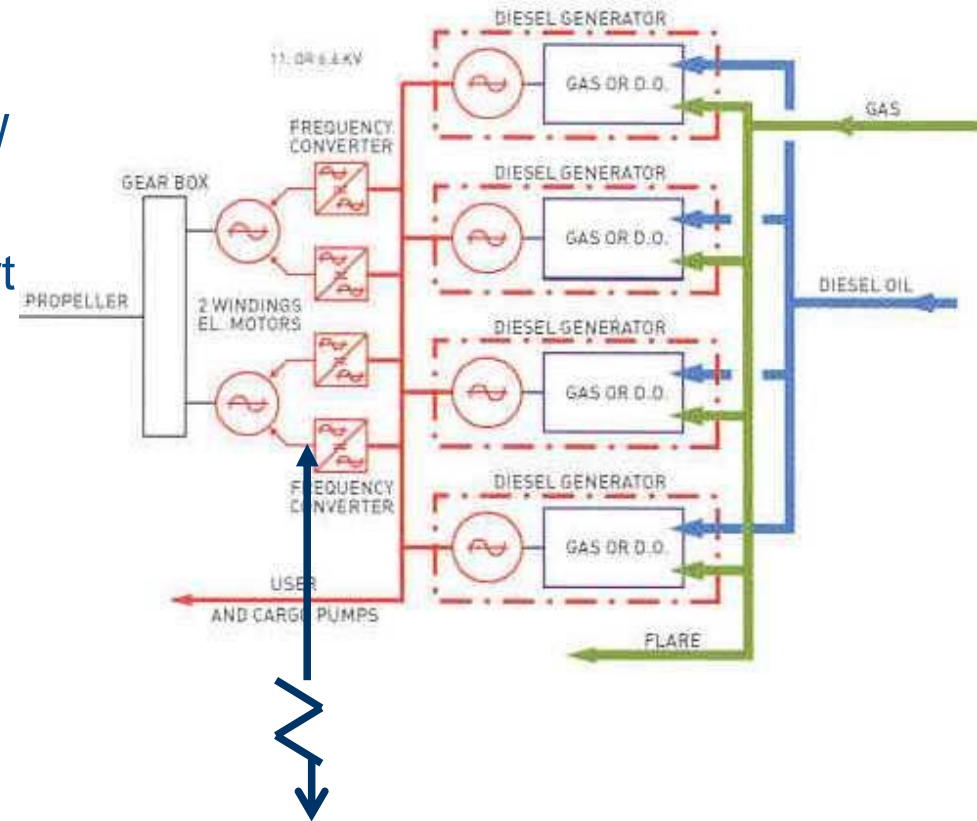

up to 25 MW to / from Local power grid when connected to terminal!

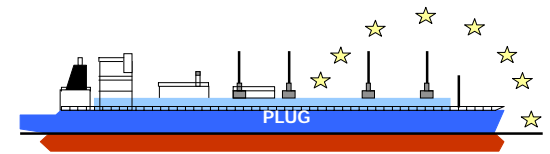

Hourly average prices per week (in €/MWh)

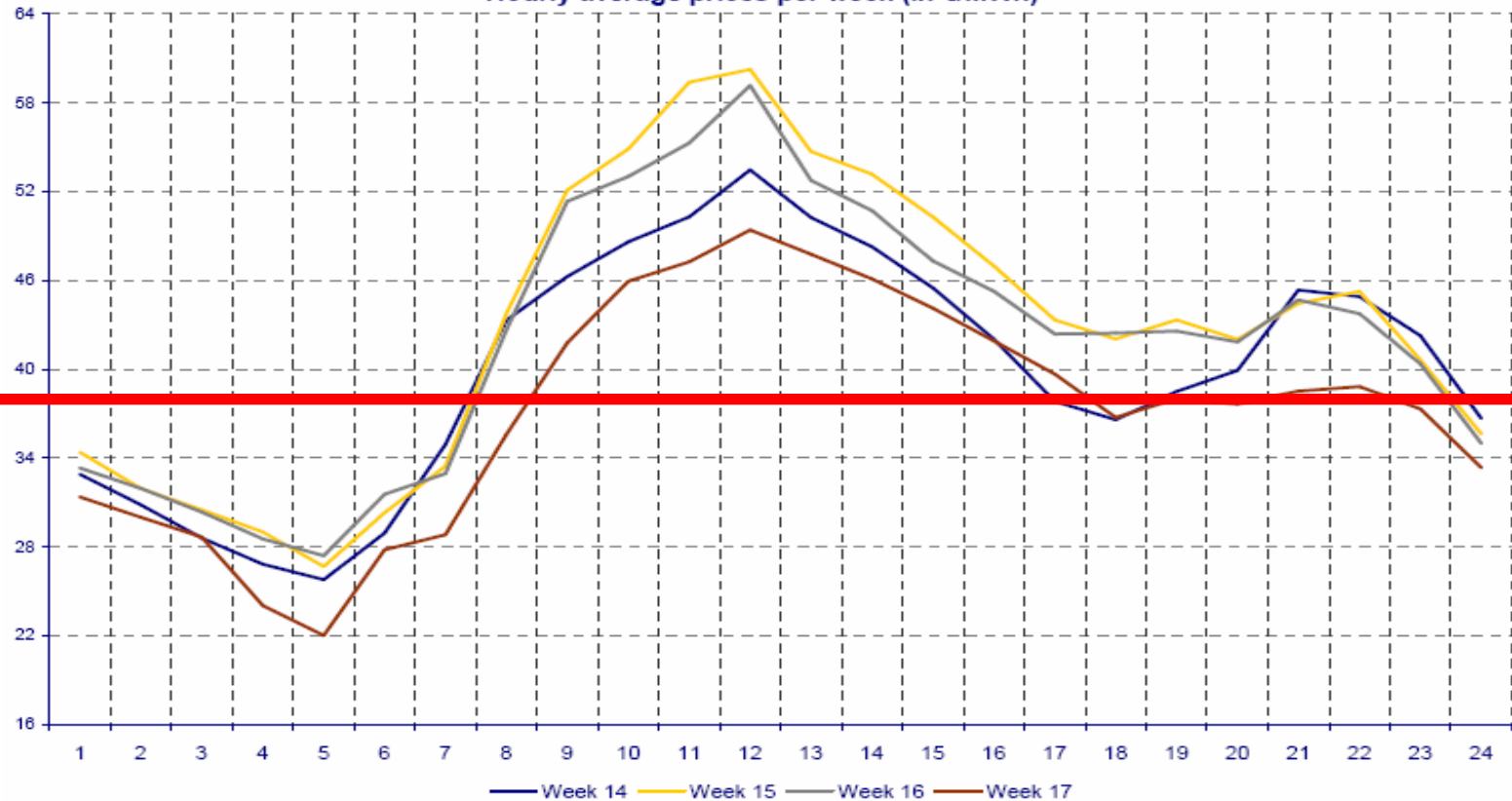

On board generation cost

- ▶ Using the fact that on board generation cost is constant, whereas power market price is fluctuating on a hourly basis, PLUG will allow operators to “play” and “beat” the power market in both directions - selling power during peak demand or buying it during low demand...

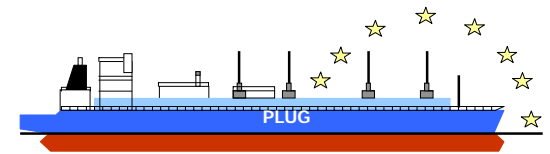

- ▶ From crew point of view, operations are as simple as for a mooring line
- ▶ Safe emergency release in less than 60 seconds
- ▶ 8 MW / 6600 V capability for “cold ironing”
- ▶ 15 minutes capability “link to the market”
- ▶ Scalable to up to 25 MW for power generation towards the shore (extra profit for DF/DE LNGCs!!!)
- ▶ Seamless transfer between on board and on shore supply

PLUG design feature

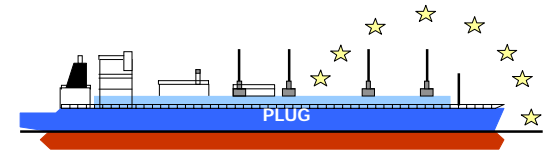

- ▶ Single connector for :
 - Power lines
 - Control/Command lines
 - Neutral / grounding
- ▶ Handling of the power line with a towing line
- ▶ Self connection / disconnection
- ▶ Emergency Release capability
- ▶ Watertight (20 m) connector when disconnected

PLUG technology

- ▶ Use of existing converters technology used for propulsion
- ▶ Proven contact technology already used on cruise vessels pods
- ▶ Power cable technology derived from sub sea power applications
- ▶ Connector technology derived from hydraulic connectors

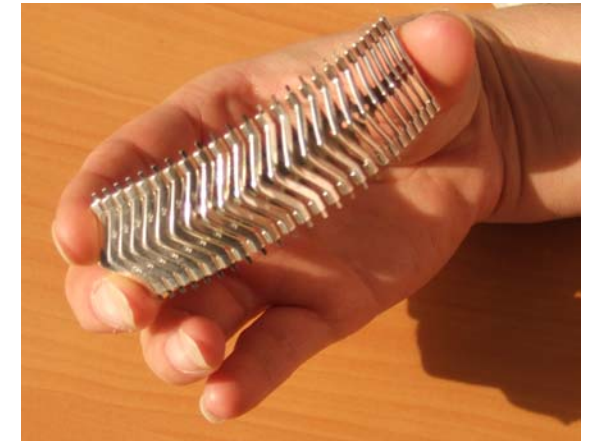
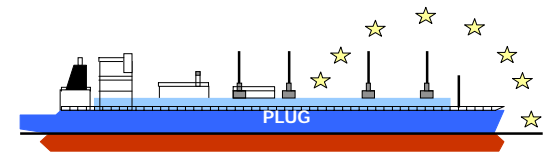
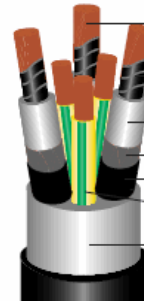

In board operations & typical dimensions

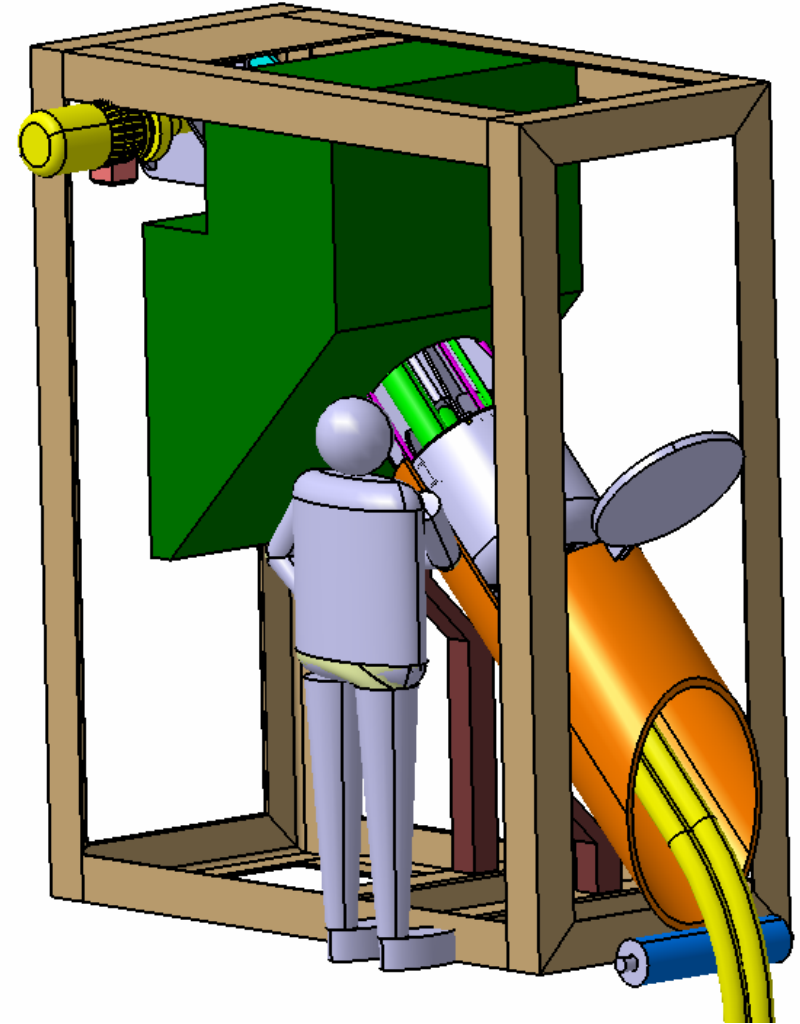
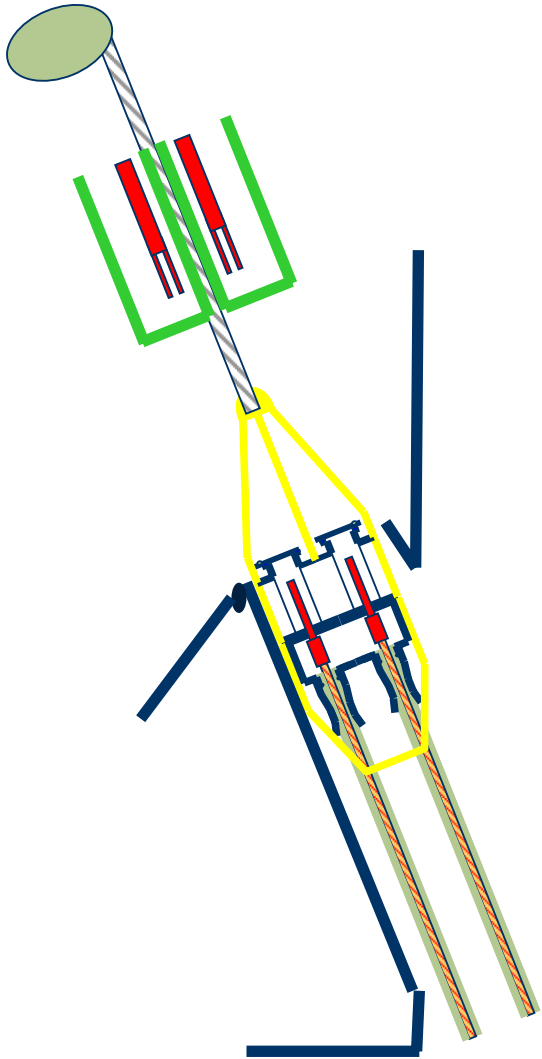
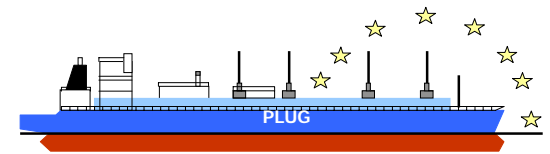

Implementation

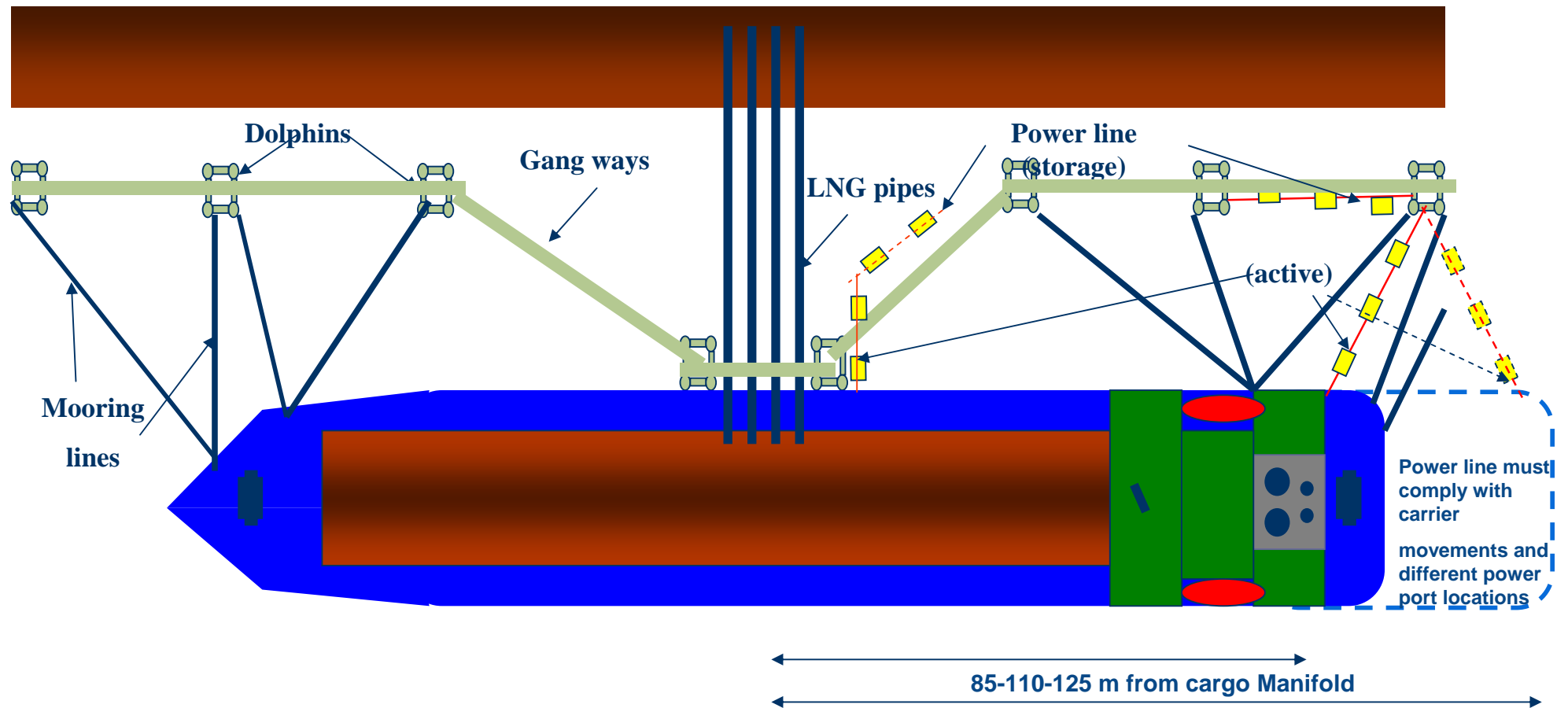
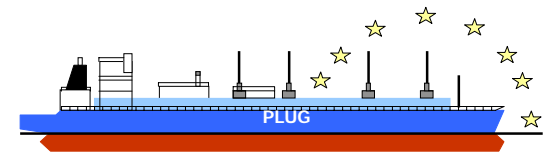

- ▶ Location either at the loading arms, or at the aft
- ▶ Submerged or above power port

Above water power port – Floating power line Operations

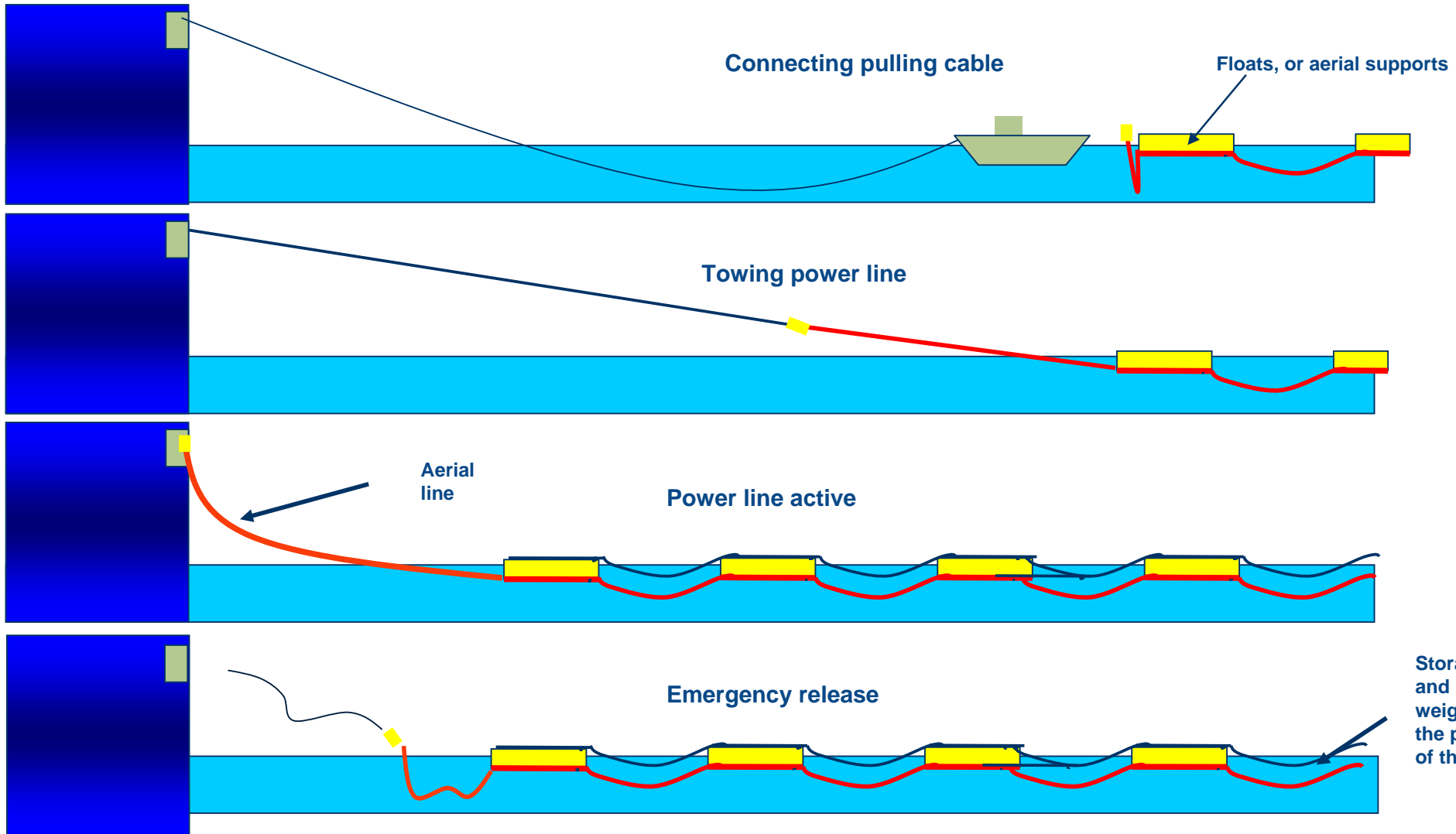
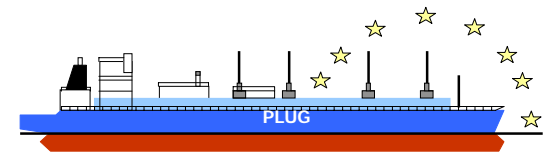

Storage towing line and power cable weight bring back the power line out of the way



Submerged water power port – Floating power line Operations

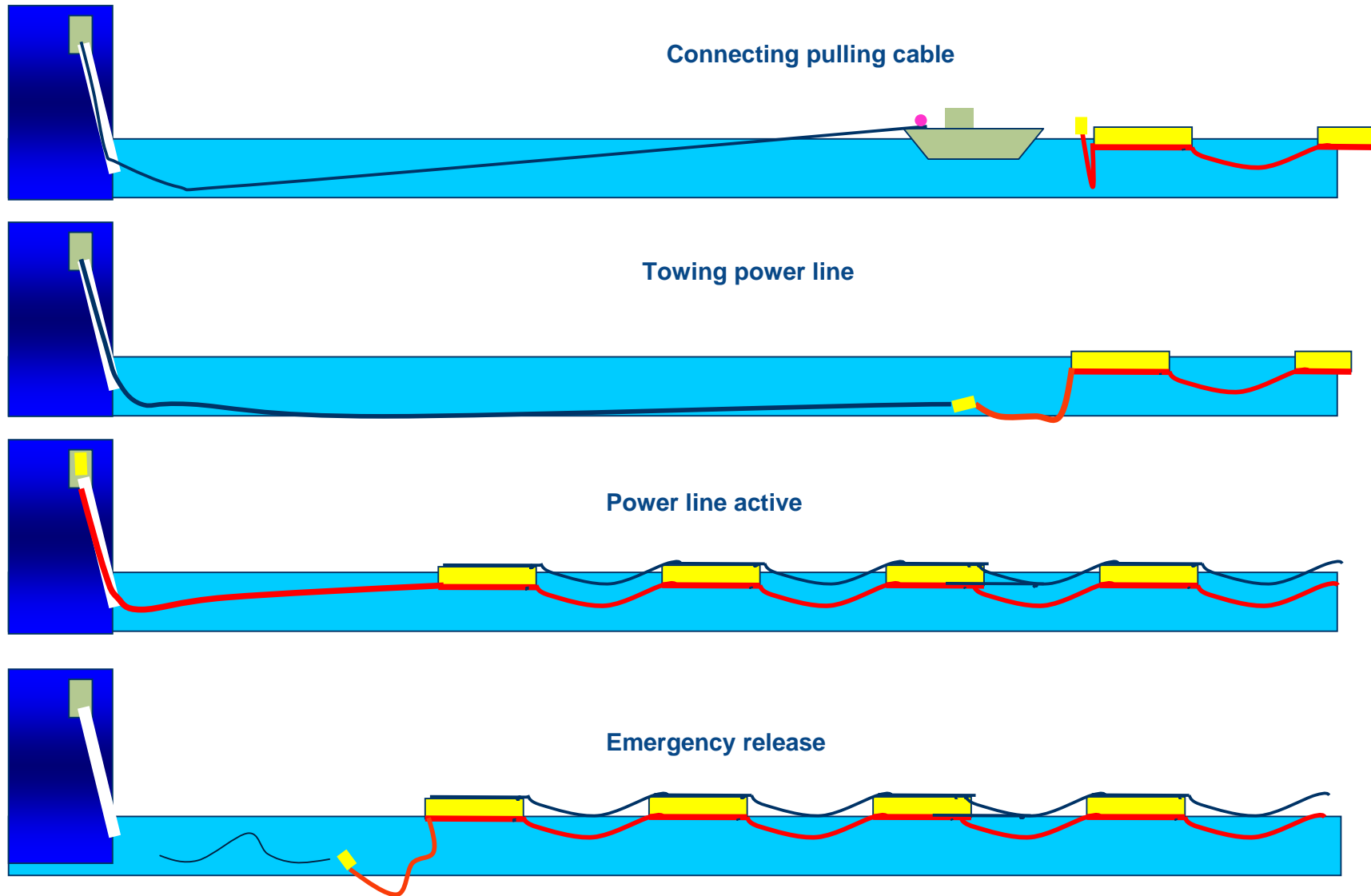
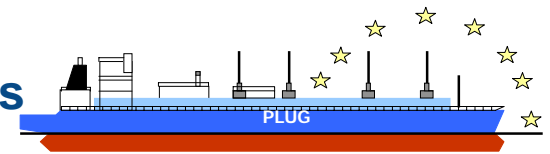

User friendly interfaces for all actors involved

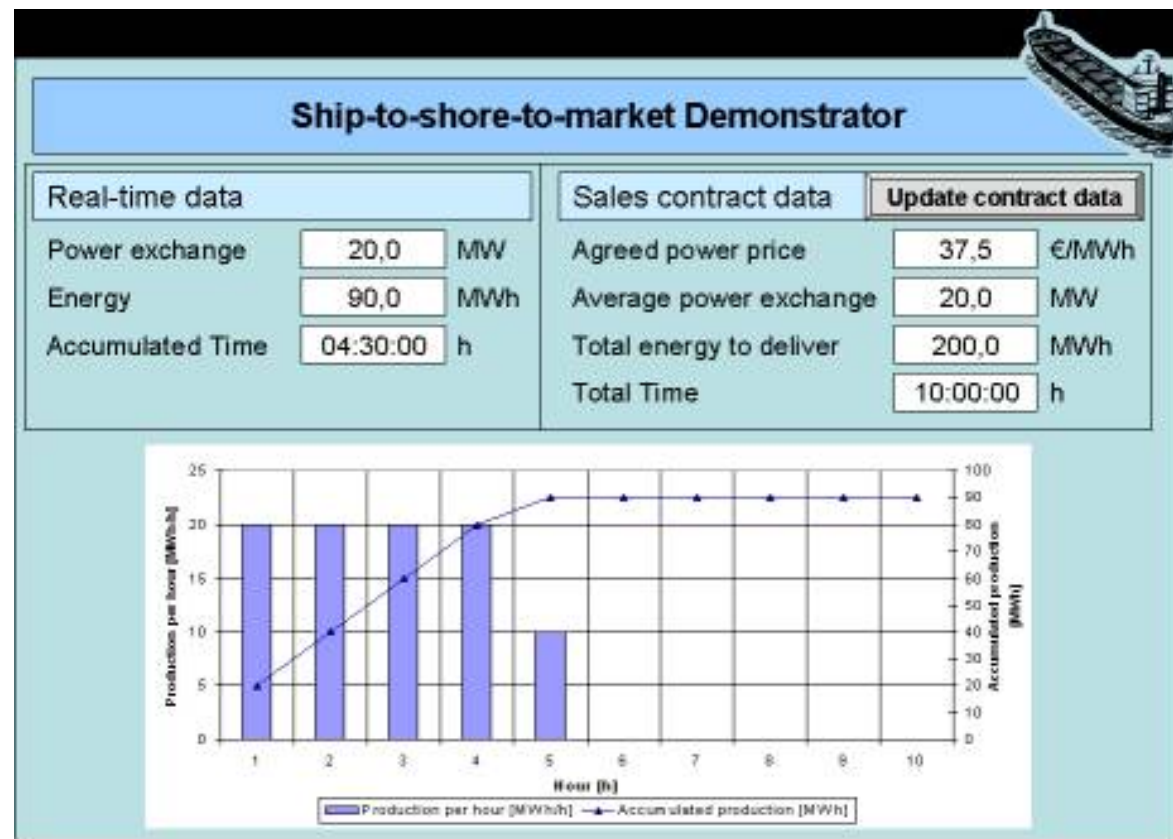
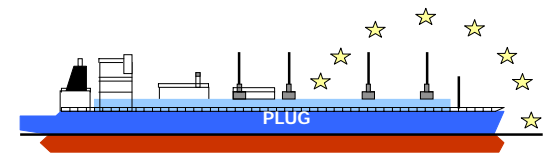

- ▶ To monitor operations and provide real time decision capability, PLUG will provide user friendly interfaces for crew, terminal operators & power network operators, power traders, power producers & consumers...

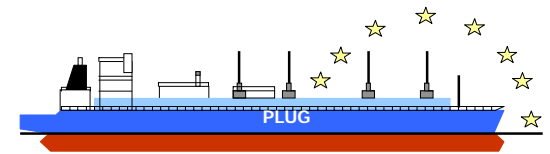

- ▶ PLUG is a 2 year R&D project led by Snecma and supported by the European commission initiated in October 2006

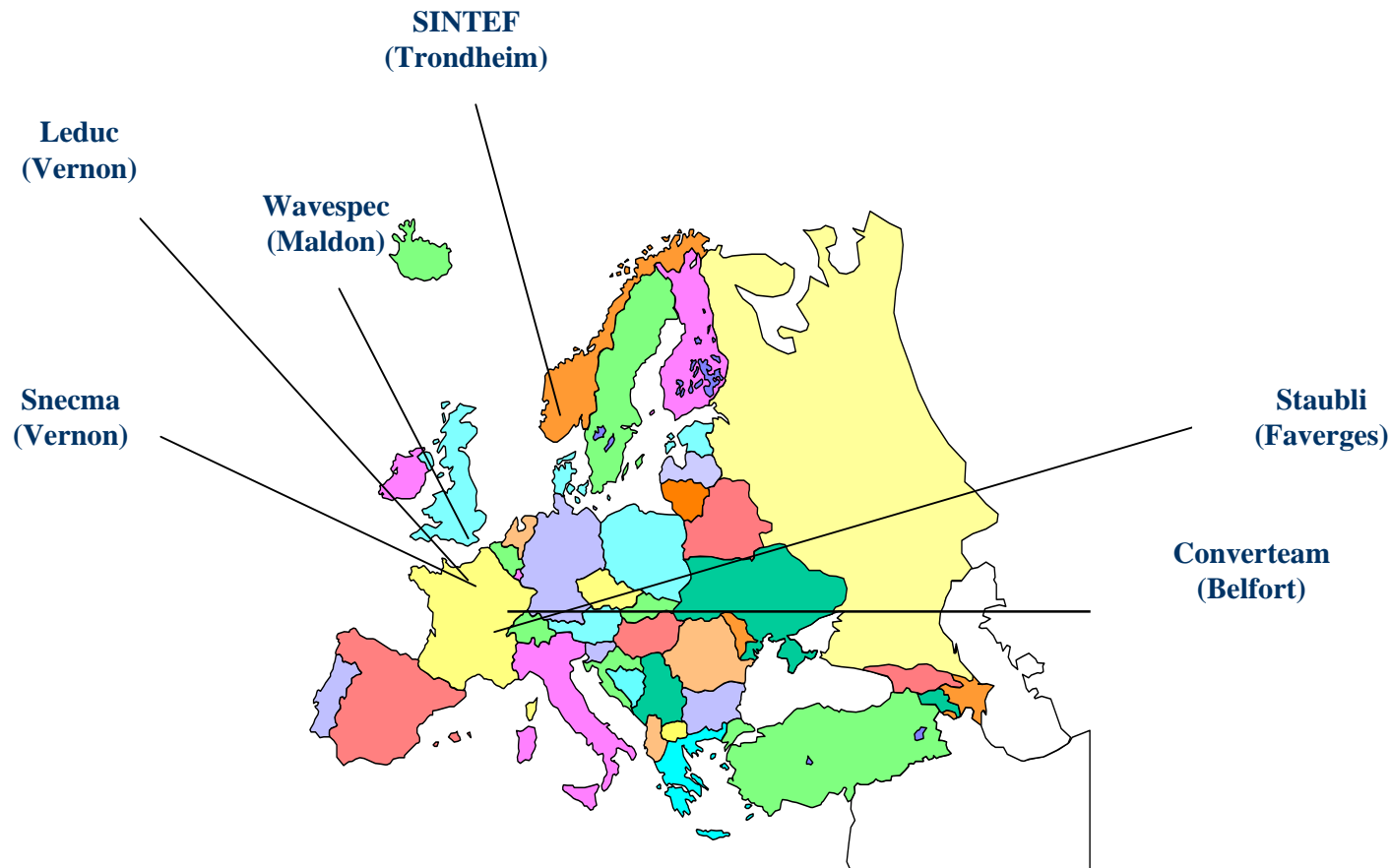

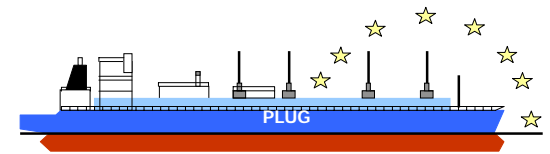

Main specifications	Completed
Enabling technologies selection	Completed
Design trade off	Completed
Detailed design	December 2007
Class approval / potential users feedback	March 2008 Some help from the audience required!
Full size test	July 2008 The audience is invited!
Case studies / market release	October 2008 Some help from the audience required!

Conclusion : Ship owners Possible strategy

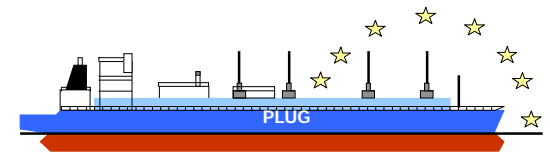

- ▶ For DF/DE / LNGC or electric propulsion Crude or LPG carriers :
Implement PLUG capability as soon as possible to start as soon as possible to get extra profitability from power generation towards the shore and be, later on, compliant with possible cold ironing requirement
- ▶ For other vessels :
Implement PLUG only when cold ironing becomes mandatory or when environmental pressure requires it

**In both cases,
PLUG implementation will allow the shipping industry
to contribute to emission reduction targets!**

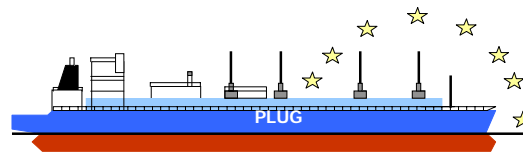

Thank you for your attention !!



Channel Photography

